

GeoMax Zoom25/50 Series

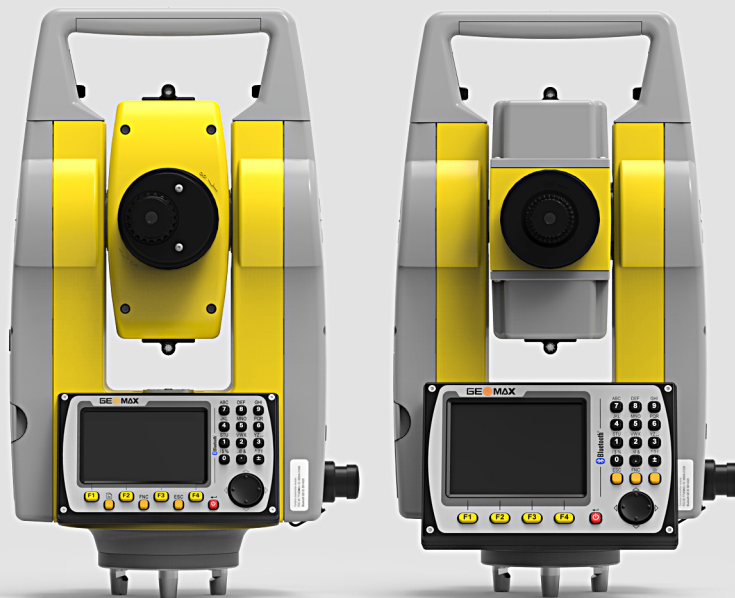

User Manual

Version 1.1
English



Introduction

Purchase

Congratulations on the purchase of a GeoMax Zoom instrument.



This manual contains important safety directions as well as instructions for setting up the product and operating it. Refer to "1 Safety Directions" for further information.

Read carefully through the User Manual before you switch on the product.

Product identification

The model and serial number of your product are indicated on the type plate.

Always refer to this information when you contact your agency or GeoMax authorised service workshop.

Trademarks

- Windows is a registered trademark of Microsoft Corporation in the United States and other countries
- *Bluetooth*® is a registered trademark of Bluetooth SIG, Inc.
- SD Logo is a trademark of SD-3C, LLC.

All other trademarks are the property of their respective owners.

Validity of this manual

	Description
General	<p>This manual applies to Zoom25 and Zoom50 instruments. Where there are differences between the instruments they are clearly described.</p> <p> The appearance of the products is subject to change without notice. The appearance of the actual product may vary slightly from the product shown in the illustrations.</p>
Telescope	<ul style="list-style-type: none">• Measuring with Prism (P) modes: When measuring distances to a prism with Electronic Distance Measurement (EDM) mode "IR", the telescope uses a wide visible red laser beam, which emerges coaxially from the telescope's objective.• Measuring with Non Prism (NP) modes: Instruments that are equipped with a reflectorless EDM additionally offer the EDM mode "Non Prism (NP)". When measuring distances with this EDM mode, the telescope uses a narrow visible red laser beam, which emerges coaxially from the telescope's objective.

NOTICE

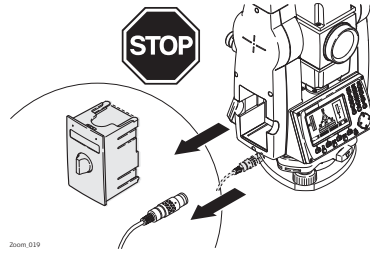

Do **NOT** remove the battery during operation of the instrument, or during the shutdown procedure.

This can result in a file system error and data loss!

Always switch off the instrument by pressing the On/Off key, and wait until the instrument has shutdown completely before removing the battery.

Table of Contents

1	Safety Directions	7
1.1	General	7
1.2	Definition of Use	7
1.3	Limits of Use	8
1.4	Responsibilities	8
1.5	Hazards of Use	8
1.6	Laser Classification	11
1.6.1	General	11
1.6.2	Labelling	12
1.6.3	Distancer, Measurements with Reflectors	13
1.6.4	Distancer, Measurements without Reflectors (Reflectorless mode)	13
1.6.5	Red Laser Pointer	14
1.6.6	Laser Plummet	16
1.7	Electromagnetic Compatibility EMC	17
1.8	FCC Statement, Applicable in U.S.	18
1.9	ICES-003 Statement, Applicable in Canada	19
2	Description of the System	20
2.1	System Components	20
2.2	Container Contents	20
2.3	Instrument Components	21
3	User Interface	23
3.1	Keyboard	23
3.2	Screen	24
3.3	Status Icons	24
3.4	Softkeys	26
3.5	Operating Principles	26
3.6	Pointsearch	27
4	Operation	29
4.1	Instrument Setup	29
4.2	Working with the Battery	32
4.3	Data Storage	32
4.4	Main Menu	33
4.5	Survey Application	33
4.6	Distance Measurements - Guidelines for Correct Results	34
5	SettingsApplications - Getting Started	35
5.1	General Settings	35
5.2	EDM Settings	38
5.3	Communication Settings	40
5.4	Unit Settings	41
6	Tools	43
6.1	Calibration	43
6.2	Auto Start Routine	43
6.3	System Information	43
6.4	Loading Software	44
6.5	Licence Keys	45
6.6	Instrument Protection with PIN	45
7	Functions	47
7.1	Overview	47
7.2	Offset	47
7.3	Column Offset	48
7.4	2 Dist. Offset	50
7.5	Brg/Dist	51
7.6	EDM Continuous	52

8	Coding	53
8.1	Coding	53
8.2	Rapid Coding	53
9	MapView Interactive Display Feature	55
9.1	Overview	55
9.2	Accessing MapView	55
9.3	MapView Components	55
	9.3.1 Screen Area	55
	9.3.2 Keys, Softkeys and Toolbar	56
	9.3.3 Point Symbols	57
10	Applications - Getting Started	58
10.1	Overview	58
10.2	Starting an Application	58
10.3	Selecting the Job	58
10.4	Selecting the Station	59
10.5	Selecting the Orientation	60
	10.5.1 Overview	60
	10.5.2 Manual Orientation	60
	10.5.3 Orientation with Coordinates	61
11	Applications	63
11.1	Common Fields	63
11.2	Survey	63
11.3	Set Out	64
11.4	Resection	65
	11.4.1 Starting Resection	65
	11.4.2 Measuring Information	66
	11.4.3 Computation Procedure	67
	11.4.4 Resection Results	67
11.5	Missing Line Measurement	69
11.6	COGO	70
	11.6.1 Starting	70
	11.6.2 Inverse and Traverse	70
	11.6.3 Intersections	71
	11.6.4 Offsets	73
	11.6.5 Line - Extension	74
11.7	Area & Volume	74
11.8	Remote Elevation	76
11.9	Reference Element - Reference Line	77
	11.9.1 Overview	77
	11.9.2 Defining the Base Line	77
	11.9.3 Defining the Reference Line	78
	11.9.4 Subapplication Measure Line & Offset	79
	11.9.5 Subapplication Setout	80
	11.9.6 Grid Setout	81
	11.9.7 Line Segment	83
11.10	Reference Element - Reference Arc	85
	11.10.1 Overview	85
	11.10.2 Defining the Reference Arc	86
	11.10.3 Subapplication Measure Line & Offset	87
	11.10.4 Subapplication Setout	87
11.11	Construction	90
	11.11.1 Starting Construction	90
	11.11.2 Layout	90
	11.11.3 As Built Check	91
11.12	Road 2D	91
11.13	Road 3D	93
	11.13.1 Starting	93
	11.13.2 Basic Terms	94

11.13.3	Creating or Uploading Alignment Files	98
11.13.4	Setout	99
11.13.5	Check	100
11.13.6	Slope Setout	101
11.13.7	Check Slope	104
11.14	Traverse	105
11.14.1	Overview	105
11.14.2	Starting and Configuring Traverse	106
11.14.3	Measuring Traverse	107
11.14.4	Moving ahead	109
11.14.5	Closing a Traverse	110
12	Data Management	113
12.1	Data Management	113
12.2	Exporting Data	113
12.3	Importing Data	115
12.4	Working with a USB Memory Stick	116
12.5	Working with Bluetooth	116
13	Calibration	118
13.1	Overview	118
13.2	Preparation	118
13.3	Calibrating Line-of-Sight and Vertical Index Error	119
13.4	Calibrating the Compensator	121
13.5	Calibrating the Circular Level of the Instrument and Tribrach	122
13.6	Inspecting the Laser Plummet of the Instrument	122
13.7	Servicing the Tripod	123
14	Care and Transport	124
14.1	Transport	124
14.2	Storage	124
14.3	Cleaning and Drying	124
15	Technical Data	126
15.1	Angle Measurement	126
15.2	Distance Measurement with Reflectors	126
15.3	Distancer, Measurements without Reflectors (Reflectorless mode)	127
15.4	Distance Measurement Reflector (Long Range)	128
15.5	Conformity to National Regulations	129
15.5.1	Dangerous Goods Regulations	129
15.6	General Technical Data of the Product	130
15.7	Scale Correction	132
15.8	Reduction Formulas	134
16	Software Licence Agreement	136
17	Glossary	137
Appendix A	Menu Tree	140
Appendix B	Directory Structure	142
Appendix C	Connector PIN Layout	143

1 Safety Directions

1.1 General

Description

The following directions enable the person responsible for the product, and the person who actually uses the equipment, to anticipate and avoid operational hazards.

The person responsible for the product must ensure that all users understand these directions and adhere to them.

About warning messages





Warning messages are an essential part of the safety concept of the instrument. They appear wherever hazards or hazardous situations can occur.

Warning messages...

- make the user alert about direct and indirect hazards concerning the use of the product.
- contain general rules of behaviour.

For the users' safety, all safety instructions and safety messages shall be strictly observed and followed! Therefore, the manual must always be available to all persons performing any tasks described here.

DANGER, WARNING, CAUTION and **NOTICE** are standardised signal words for identifying levels of hazards and risks related to personal injury and property damage. For your safety, it is important to read and fully understand the following table with the different signal words and their definitions! Supplementary safety information symbols may be placed within a warning message as well as supplementary text.

Type	Description
 DANGER	Indicates an imminently hazardous situation which, if not avoided, will result in death or serious injury.
 WARNING	Indicates a potentially hazardous situation or an unintended use which, if not avoided, could result in death or serious injury.
 CAUTION	Indicates a potentially hazardous situation or an unintended use which, if not avoided, may result in minor or moderate injury.
NOTICE	Indicates a potentially hazardous situation or an unintended use which, if not avoided, may result in appreciable material, financial and environmental damage.
	Important paragraphs which must be adhered to in practice as they enable the product to be used in a technically correct and efficient manner.

1.2 Definition of Use

Intended use

- Measuring horizontal and vertical angles.
- Measuring distances.
- Recording measurements.
- Visualizing the aiming direction and vertical axis.
- Data communication with external appliances.
- Computing by means of software.

Reasonably foreseeable misuse

- Use of the product without instruction.
- Use outside of the intended use and limits.
- Disabling safety systems.
- Removal of hazard notices.
- Opening the product using tools, for example screwdriver, unless this is specifically permitted for certain functions.
- Modification or conversion of the product.
- Use after misappropriation.
- Use of products with obviously recognisable damages or defects.
- Use with accessories from other manufacturers without the prior explicit approval of GeoMax.
- Aiming directly into the sun.
- Inadequate safeguards at the working site.
- Deliberate dazzling of third parties.
- Controlling of machines, moving objects or similar monitoring application without additional control- and safety installations.

1.3

Limits of Use

Environment

Suitable for use in an atmosphere appropriate for permanent human habitation: not suitable for use in aggressive or explosive environments.

WARNING

Working in hazardous areas, or close to electrical installations or similar situations.

Life Risk.

Precautions:

- ▶ Local safety authorities and safety experts must be contacted by the person responsible for the product before working in such conditions.

1.4

Responsibilities

Manufacturer of the product

GeoMax AG, CH-9443 Widnau, hereinafter referred to as GeoMax, is responsible for supplying the product, including the user manual and original accessories, in a safe condition.

Person responsible for the product

The person responsible for the product has the following duties:

- To understand the safety instructions on the product and the instructions in the user manual.
- To ensure that it is used in accordance with the instructions.
- To be familiar with local regulations relating to safety and accident prevention.
- To inform GeoMax immediately if the product and the application becomes unsafe.
- To ensure that the national laws, regulations and conditions for the operation of e.g. radio transmitters or lasers are respected.

1.5

Hazards of Use

CAUTION

Dropping, misusing, modifying, storing the product for long periods or transporting the product

Watch out for erroneous measurement results.

Precautions:

- ▶ Periodically carry out test measurements and perform the field adjustments indicated in the User Manual, particularly after the product has been subjected to abnormal use as well as before and after important measurements.

DANGER

Risk of electrocution

Because of the risk of electrocution, it is dangerous to use poles, levelling staffs and extensions in the vicinity of electrical installations such as power cables or electrical railways.

Precautions:

- ▶ Keep at a safe distance from electrical installations. If it is essential to work in this environment, first contact the safety authorities responsible for the electrical installations and follow their instructions.



CAUTION

Be careful when pointing the product towards the sun, because the telescope functions as a magnifying glass and can injure your eyes and/or cause damage inside the product.

Precautions:

- ▶ Do not point the product directly at the sun.

WARNING

Distraction/loss of attention

During dynamic applications, for example stakeout procedures, there is a danger of accidents occurring if the user does not pay attention to the environmental conditions around, for example obstacles, excavations or traffic.

Precautions:

- ▶ The person responsible for the product must make all users fully aware of the existing dangers.

WARNING

Inadequate securing of the working site.

This can lead to dangerous situations, for example in traffic, on building sites and at industrial installations.

Precautions:

- ▶ Always ensure that the working site is adequately secured.
- ▶ Adhere to the regulations governing safety, accident prevention and road traffic.

CAUTION

Not properly secured accessories.

If the accessories used with the product are not properly secured and the product is subjected to mechanical shock, for example blows or falling, the product may be damaged or people can sustain injury.

Precautions:

- ▶ When setting up the product, make sure that the accessories are correctly adapted, fitted, secured, and locked in position.
- ▶ Avoid subjecting the product to mechanical stress.

 **WARNING**

Lightning strike

If the product is used with accessories, for example masts, staffs, poles, you may increase the risk of being struck by lightning.

Precautions:

- ▶ Do not use the product in a thunderstorm.

 **CAUTION**

Inappropriate mechanical influences to batteries

During the transport, shipping or disposal of batteries it is possible for inappropriate mechanical influences to constitute a fire hazard.

Precautions:

- ▶ Before shipping the product or disposing of it, discharge the batteries by running the product until they are flat.
- ▶ When transporting or shipping batteries, the person in charge of the product must ensure that the applicable national and international rules and regulations are observed.
- ▶ Before transportation or shipping contact your local passenger or freight transport company.

 **WARNING**

Exposure of batteries to high mechanical stress, high ambient temperatures or immersion into fluids

This can cause leakage, fire or explosion of the batteries.

Precautions:

- ▶ Protect the batteries from mechanical influences and high ambient temperatures. Do not drop or immerse batteries into fluids.

 **WARNING**

Short circuit of battery terminals

If battery terminals are short circuited e.g. by coming in contact with jewellery, keys, metallised paper or other metals, the battery can overheat and cause injury or fire, for example by storing or transporting in pockets.

Precautions:

- ▶ Make sure that the battery terminals do not come into contact with metallic objects.

 **WARNING**

If you open the product, either of the following actions may cause you to receive an electric shock.

- Touching live components
- Using the product after incorrect attempts were made to carry out repairs

Precautions:

- ▶ Do not open the product. Only GeoMax authorised service workshops are entitled to repair these products.

⚠ WARNING

If the product is improperly disposed of, the following can happen:

- If polymer parts are burnt, poisonous gases are produced which may impair health.
- If batteries are damaged or are heated strongly, they can explode and cause poisoning, burning, corrosion or environmental contamination.
- By disposing of the product irresponsibly you may enable unauthorised persons to use it in contravention of the regulations, exposing themselves and third parties to the risk of severe injury and rendering the environment liable to contamination.

Precautions:

▶



The product must not be disposed with household waste. Dispose of the product appropriately in accordance with the national regulations in force in your country. Always prevent access to the product by unauthorised personnel.

Product-specific treatment and waste management information is available from GeoMax AG.

⚠ WARNING

Only GeoMax authorised service workshops are entitled to repair these products.

1.6

Laser Classification

1.6.1

General

General

The following chapters provide instructions and training information about laser safety according to international standard IEC 60825-1 (2014-05) and technical report IEC TR 60825-14 (2004-02). The information enables the person responsible for the product and the person who actually uses the equipment, to anticipate and avoid operational hazards.



According to IEC TR 60825-14 (2004-02), products classified as laser class 1, class 2 and class 3R do not require:

- laser safety officer involvement,
- protective clothes and eyewear,
- special warning signs in the laser working area

if used and operated as defined in this User Manual due to the low eye hazard level.







National laws and local regulations could impose more stringent instructions for the safe use of lasers than IEC 60825-1 (2014-05) and IEC TR 60825-14 (2004-02).

1.6.2

Labelling

Labelling Zoom25

Model: Zoom25 Art.No.: 1 2 3 4 5 6
 Equip.No.: 1234567
 Power: 12V/7.4V , 1.5A max. S.No.: 1 2 3 4 5 6
 GeoMax AG CH-9443 Widnau
 Manufactured: 20XX   

Made in China Developed by Hexagon Group Sweden
 Complies with FDA performance standards for laser products except for deviations pursuant to Laser Notice No. 50, dated June 24, 2007.
 This device complies with part 15 of the FCC Rules. Operation is subject to the following two conditions:
 (1) This device may not cause harmful interference, and
 (2) This device must accept any interference received, including interference that may cause undesired operation.



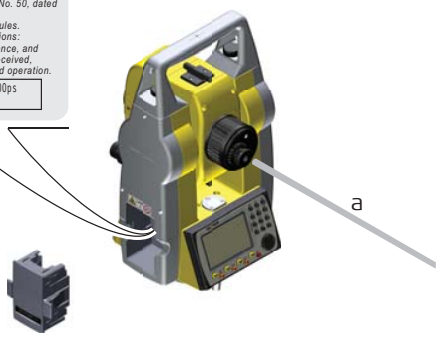

P_{av} = 4,8mW A = 658nm t_p = 800ps
 IEC 60825-1:2014



a Laser beam

0015215_001

Labelling Zoom50

Model: Zoom50 Art.No.: 1 2 3 4 5 6
 Equip.No.: 1234567
 Power: 12V/7.4V , 1.5A max. S.No.: 1 2 3 4 5 6
 GeoMax AG CH-9443 Widnau
 Manufactured: 20XX   

Made in China Developed by Hexagon Group Sweden
 Complies with FDA performance standards for laser products except for deviations pursuant to Laser Notice No. 50, dated June 24, 2007.
 This device complies with part 15 of the FCC Rules. Operation is subject to the following two conditions:
 (1) This device may not cause harmful interference, and
 (2) This device must accept any interference received, including interference that may cause undesired operation.

P_{av} = 4,8mW A = 658nm t_p = 800ps
 IEC 60825-1:2014

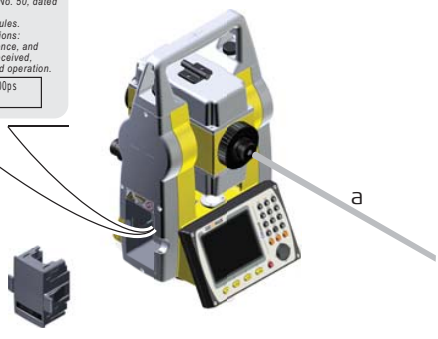

a Laser beam

0015211_001

Labelling internal battery ZBA400

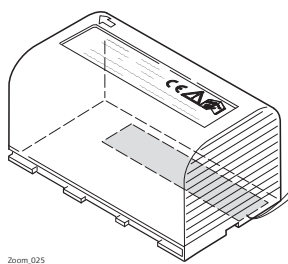

This device complies with part 15 of the FCC Rules. Operation is subject to the following two conditions: (1) This device may not cause harmful interference, and (2) this device must accept any interference received, including interference that may cause undesired operation.

 US LISTED
 ITE Accessory
 E179078 . 70YL

Zoom 025

1.6.3

Distancer, Measurements with Reflectors

General

The EDM module built into the product produces a visible laser beam which emerges from the telescope objective.

The laser product described in this section is classified as laser class 1 in accordance with:

- IEC 60825-1 (2014-05): "Safety of laser products"

These products are safe under reasonably foreseeable conditions of operation and are not harmful to the eyes provided that the products are used and maintained in accordance with this User Manual.

Description	Value (Zoom25)	Value (Zoom50)
Maximum average radiant power	0.95mW	0.33 mW
Pulse duration	12 ms/cw	800 ps
Pulse repetition frequency	320 MHz	100 MHz
Wavelength	635 nm	658 nm

1.6.4

Distancer, Measurements without Reflectors (Reflectorless mode)

General

The EDM module built into the product produces a visible laser beam which emerges from the telescope objective.

The laser product described in this section is classified as laser class 3R in accordance with:

- IEC 60825-1 (2014-05): "Safety of laser products"

Direct intrabeam viewing may be hazardous (low eye hazard level), in particular for deliberate ocular exposure. The beam may cause dazzle, flash-blindness and after-images, particularly under low ambient light conditions. The risk of injury for laser class 3R products is limited because of:

- a) unintentional exposure would rarely reflect worst case conditions of (e.g.) beam alignment with the pupil, worst case accommodation,
- b) inherent safety margin in the maximum permissible exposure to laser radiation (MPE)
- c) natural aversion behaviour for exposure to bright light for the case of visible radiation.

Description	Value (Zoom25 N5)	Value (Zoom50 A5, A10)
Maximum average radiant power	4.8mW	4.8mW
Pulse duration	400ps	800ps
Pulse repetition frequency	320MHz	100MHz
Wavelength	658nm	658nm
Beam divergence	0.2mrad x 0.3mrad	0.2mrad x 0.3mrad
NOHD (Nominal Ocular Hazard Distance) @ 0.25s	46m	44m

CAUTION

From a safety perspective, class 3R laser products should be treated as potentially hazardous.

Precautions:

- ▶ 1. Prevent direct eye exposure to the beam.
- ▶ 2. Do not direct the beam at other people.

CAUTION

Potential hazards are not only related to direct beams but also to reflected beams aimed at reflecting surfaces such as prisms, windows, mirrors, metallic surfaces, etc.

Precautions:

- ▶ 1. Do not aim at areas that are essentially reflective, such as a mirror, or which could emit unwanted reflections.
- ▶ 2. Do not look through or beside the optical sight at prisms or reflecting objects when the laser is switched on, in laser pointer or distance measurement mode. Aiming at prisms is only permitted when looking through the telescope.

Labelling



0015212.001

1.6.5

Red Laser Pointer

General

The laser pointer built into the product produces a visible red laser beam which emerges from the telescope objective.

The laser product described in this section is classified as laser class 3R in accordance with:

- IEC 60825-1 (2014-05): "Safety of laser products"

Direct intrabeam viewing may be hazardous (low eye hazard level), in particular for deliberate ocular exposure. The beam may cause dazzle, flash-blindness and after-images, particularly under low ambient light conditions. The risk of injury for laser class 3R products is limited because of:

- a) unintentional exposure would rarely reflect worst case conditions of (e.g.) beam alignment with the pupil, worst case accommodation,
- b) inherent safety margin in the maximum permissible exposure to laser radiation (MPE)
- c) natural aversion behaviour for exposure to bright light for the case of visible radiation.

Description	Value (Zoom25N5)	Value (Zoom50A5, A10)
Maximum average radiant power	4.8mW	4.8mW
Pulse duration	400ps	800ps
Pulse repetition frequency	320MHz	100MHz
Wavelength	658nm	658nm
Beam divergence	0.2mrad x 0.3mrad	0.2mrad x 0.3mrad
NOHD (Nominal Ocular Hazard Distance) @ 0.25s	46m	44m

⚠ CAUTION

From a safety perspective, class 3R laser products should be treated as potentially hazardous.

Precautions:

- ▶ 1. Prevent direct eye exposure to the beam.
- ▶ 2. Do not direct the beam at other people.

⚠ CAUTION

Potential hazards are not only related to direct beams but also to reflected beams aimed at reflecting surfaces such as prisms, windows, mirrors, metallic surfaces, etc.

Precautions:

- ▶ 1. Do not aim at areas that are essentially reflective, such as a mirror, or which could emit unwanted reflections.
- ▶ 2. Do not look through or beside the optical sight at prisms or reflecting objects when the laser is switched on, in laser pointer or distance measurement mode. Aiming at prisms is only permitted when looking through the telescope.



0015212.001

1.6.6

Laser Plummet

General

The laser plummet built into the product produces a visible red laser beam which emerges from the bottom of the product.

The laser product described in this section is classified as laser class 2 in accordance with:

- IEC 60825-1 (2014-05): "Safety of laser products"

These products are safe for momentary exposures but can be hazardous for deliberate staring into the beam. The beam may cause dazzle, flash-blindness and after-images, particularly under low ambient light conditions.

Description	Value
Wavelength	640 nm
Maximum average radiant power	0.95 mW
Pulse duration	10 ms - cw
Pulse repetition frequency (PRF)	1 kHz
Beam divergence	<1.5 mrad

CAUTION

From a safety perspective, class 2 laser products are not inherently safe for the eyes.

Precautions:

- 1. Avoid staring into the beam or viewing it through optical instruments.
- 2. Avoid pointing the beam at other people or at animals.

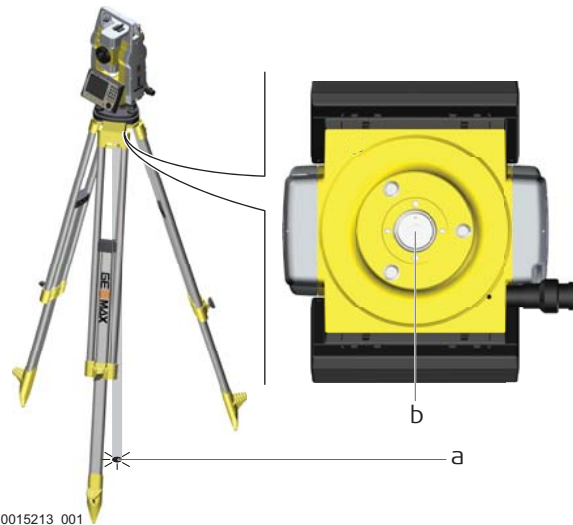

- a Laser beam
- b Exit for laser beam

1.7

Electromagnetic Compatibility EMC

Description

The term Electromagnetic Compatibility is taken to mean the capability of the product to function smoothly in an environment where electromagnetic radiation and electrostatic discharges are present, and without causing electromagnetic disturbances to other equipment.

WARNING

Electromagnetic radiation can cause disturbances in other equipment.

Although the product meets the strict regulations and standards which are in force in this respect, GeoMax cannot completely exclude the possibility that other equipment may be disturbed.

CAUTION

There is a risk that disturbances may be caused in other equipment if the product is used with accessories from other manufacturers, for example field computers, personal computers or other electronic equipment, non-standard cables or external batteries.

Precautions:

- ▶ Use only the equipment and accessories recommended by GeoMax. When combined with the product, they meet the strict requirements stipulated by the guidelines and standards. When using computers or other electronic equipment, pay attention to the information about electromagnetic compatibility provided by the manufacturer.

 **CAUTION**

Disturbances caused by electromagnetic radiation can result in erroneous measurements. Although the product meets the strict regulations and standards which are in force in this respect, GeoMax cannot completely exclude the possibility that the product may be disturbed by intense electromagnetic radiation, for example, near radio transmitters, two-way radios or diesel generators.

Precautions:

- ▶ Check the plausibility of results obtained under these conditions.

 **CAUTION**

Electromagnetic radiation due to improper connection of cables

If the product is operated with connecting cables attached at only one of their two ends, for example external supply cables, interface cables, the permitted level of electromagnetic radiation may be exceeded and the correct functioning of other products may be impaired.

Precautions:

- ▶ While the product is in use, connecting cables, for example product to external battery, product to computer, must be connected at both ends.

Bluetooth

Use of product with Bluetooth:

 **WARNING**

Electromagnetic radiation can cause disturbances in other equipment, in installations, in medical devices, for example pacemakers or hearing aids and in aircraft. It can also affect humans and animals.

Precautions:

- ▶ Although the product meets in combination with radio or digital cellular phone devices recommended by GeoMax the strict regulations and standards which are in force in this respect, GeoMax cannot completely exclude the possibility that other equipment may be disturbed or that humans or animals may be affected.
 - Do not operate the product with radio or digital cellular phone devices in the vicinity of filling stations or chemical installations, or in other areas where an explosion hazard exists.
 - Do not operate the product with radio or digital cellular phone devices near to medical equipment.
 - Do not operate the product with radio or digital cellular phone devices in aircraft.

1.8

FCC Statement, Applicable in U.S.



The greyed paragraph below is only applicable for products without radio.

 **WARNING**

This equipment has been tested and found to comply with the limits for a Class B digital device, pursuant to part 15 of the FCC rules.

These limits are designed to provide reasonable protection against harmful interference in a residential installation.

This equipment generates, uses and can radiate radio frequency energy and, if not installed and used in accordance with the instructions, may cause harmful interference to radio communications. However, there is no guarantee that interference will not occur in a particular installation.

If this equipment does cause harmful interference to radio or television reception, which can be determined by turning the equipment off and on, the user is encouraged to try to correct the interference by one or more of the following measures:

- Reorient or relocate the receiving antenna.
- Increase the separation between the equipment and the receiver.
- Connect the equipment into an outlet on a circuit different from that to which the receiver is connected.
- Consult the dealer or an experienced radio/TV technician for help.

 **WARNING**

Changes or modifications not expressly approved by GeoMax for compliance could void the user's authority to operate the equipment.

1.9

ICES-003 Statement, Applicable in Canada

 **WARNING**

This Class (B) digital apparatus complies with Canadian ICES-003.
Cet appareil numérique de la classe (B) est conforme à la norme NMB-003 du Canada.

Canada Compliance Statement

This device complies with Industry Canada's license-exempt RSSs. Operation is subject to the following two conditions:

1. This device may not cause interference; and
2. This device must accept any interference, including interference that may cause undesired operation of the device.

Canada Déclaration de Conformité

Le présent appareil est conforme aux CNR d'Industrie Canada applicables aux appareils radio exempts de licence. L'exploitation est autorisée aux deux conditions suivantes:

1. l'appareil ne doit pas produire de brouillage;
2. l'appareil doit accepter tout brouillage radioélectrique subi, même si le brouillage est susceptible d'en compromettre le fonctionnement.

2 Description of the System

2.1 System Components

Main components

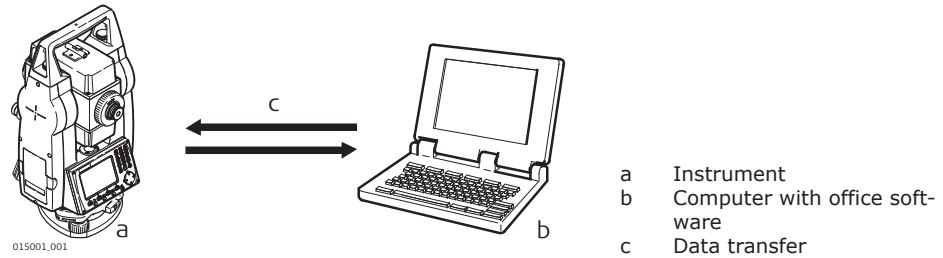

Component	Description
Instrument	An instrument for measuring, calculating and capturing data. Ideally suited for tasks from simple measurements to complex applications. The various lines have a range of accuracy classes and support different features. All lines can be connected with GGO or GGO Tools to view, exchange and manage data.
Firmware	The firmware package installed on the instrument. Consists of a standard base operating system with optional extra features.
Office software	An office software consisting of a suite of standard and extended programs for the viewing, exchanging, managing and post-processing of data.
Data transfer	Data can be always transferred between an instrument and a computer by a data transfer cable, USB memory stick, USB cable or Bluetooth.

2.2 Container Contents

Container contents part 1 of 2

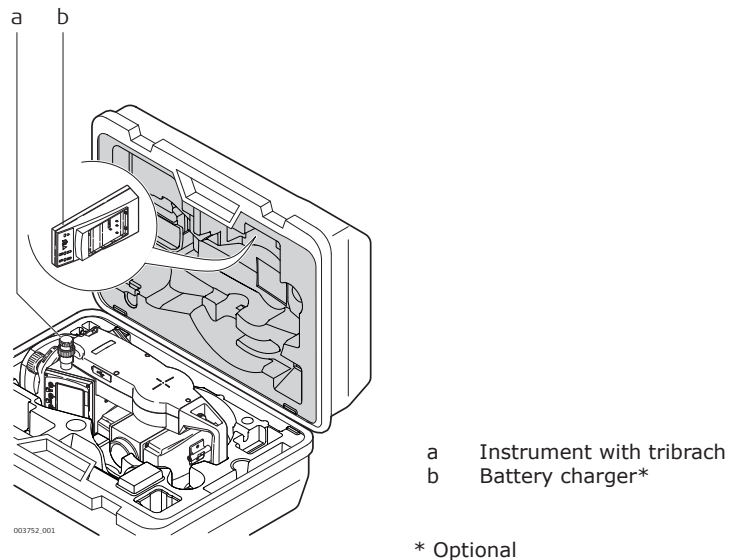

**Container contents part 2
of 2**

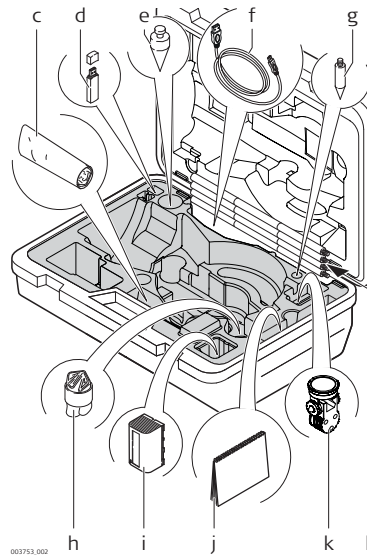

- c Adjustment tools
- d USB memory stick
- e Plumb bob
- f USB cable*
- g Tip for mini prism pole*
- h Protective cover
- i Battery*
- j Quick Guide
- k Mini prism*
- l Mini prism pole*

* Optional

2.3 Instrument Components

**Instrument components
part 1 of 2**

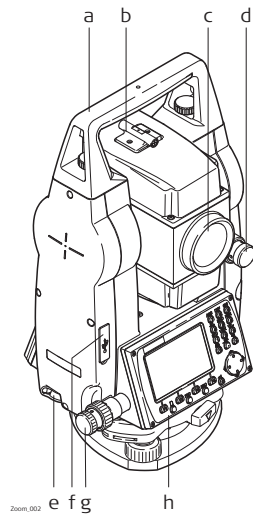

- a Detachable carrying handle
- b Optical sight
- c Objective with integrated Electronic Distance Measurement (EDM). Exit for EDM laser beam
- d Vertical drive
- e Interface RS232/USB
- f USB host port
- g Horizontal drive
- h Second keyboard*

* Optional

Instrument components
part 2 of 2

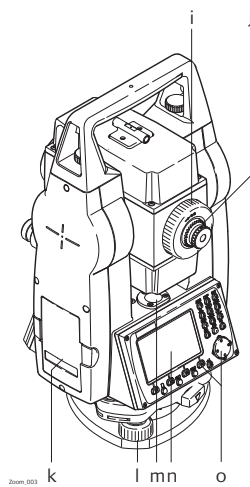

- i Focusing telescope image
- j Eyepiece; focusing graticule
- k Battery cover
- l Foot screw
- m Circular level
- n Display
- o Keyboard

3

User Interface

3.1

Keyboard

Keyboard



The keyboard layout may differ depending on the instrument model.

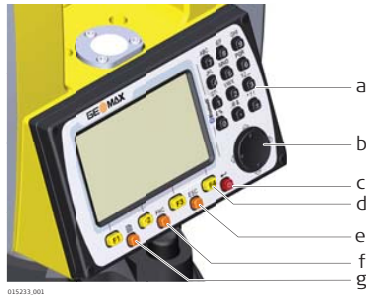

- a Alphanumeric keypad
- b Navigation key
- c **ENTER** key
- d Function keys **F1** to **F4**
- e **ESC** key
- f **FNC** key
- g **PAGE** key

Keys

Key	Description
	Page key. Displays the next screen when several screens are available.
	FNC key. Quick-access to measurement supporting functions.
	Navigation key. Controls the focus bar within the screen and the entry bar within a field.
	ENTER key. Confirms an entry and continues to the next field.
	ESC key. Quits a screen or edit mode without saving changes. Returns to next higher level.
	Function keys that are assigned the variable functions displayed at the bottom of the screen.

Key	Description
	Alphanumeric keypad for entry of text and numerical values.

3.2

Screen

Screen

The instruments are available with Black&White or with Color&Touch display.

All shown screens are examples. It is possible that local firmware versions are different to the basic version.

Black&White screen:

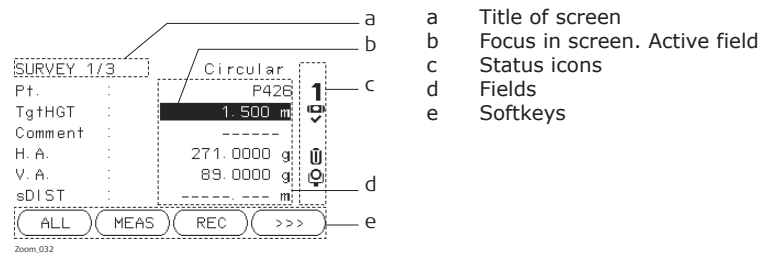

Color&Touch screen:

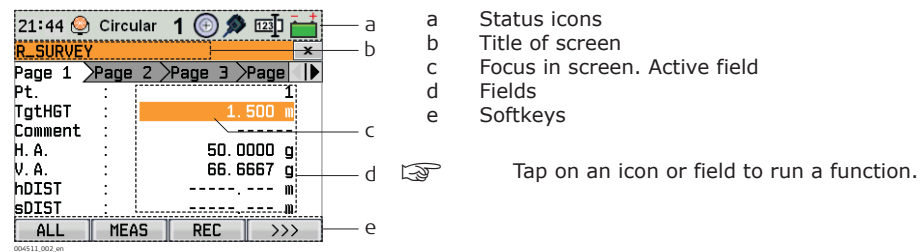

3.3



























Status Icons

Description

The icons provide status information related to basic instrument functions. Depending on the display type, different icons are displayed.

Icons

Icon	Description				
<table border="1"> <thead> <tr> <th>B&W</th> <th>C&T</th> </tr> </thead> <tbody> <tr> <td></td> <td></td> </tr> </tbody> </table>	B&W	C&T			<p>100%</p> <p>The battery symbol indicates the level of the remaining battery capacity. For C&T: Tapping the icon opens the SYSTEM INFO screen.</p>
B&W	C&T				

Icon		Description	
B&W	C&T		
		75%	
		50%	
		25%	
		5%	
		Critical	
		On	Compensator is on. For C&T: Tapping the icon opens the Level Up screen.
		Out of range	Compensator is tilted and out of level. For C&T: Tapping the icon opens the Level Up screen.
		Off	Compensator is off. For C&T: Tapping the icon opens the SETTINGS screen.
			IR EDM mode for measuring to prisms and reflective targets. For C&T: Tapping the icon opens the EDM SETTINGS screen.
			Foil EDM mode for measuring to reflective foils and reflector tapes. For C&T: Tapping the icon opens the EDM SETTINGS screen.
			RL EDM mode for measuring to all targets. For C&T: Tapping the icon opens the EDM SETTINGS screen.
			RL-Long Range EDM mode for measuring to prisms. For C&T: Tapping the icon opens the EDM SETTINGS screen.
NUM			Keypad is set to numeric mode.
a			Keypad is set to alphanumeric mode.
1			Indicates telescope position is face I. For C&T: Tapping the icon opens the Level Up screen.
2			Indicates telescope position is face II. For C&T: Tapping the icon opens the Level Up screen.
			Bluetooth is connected. If there is a cross beside the icon, the Bluetooth communication port is selected, but the status is inactive. For C&T: Tapping the icon opens the COMMUNICATION SETTINGS screen.
			USB communication port is selected. For C&T: Tapping the icon opens the COMMUNICATION SETTINGS screen.

Icon		Description
B&W	C&T	
		RS232 communication port is selected. For C&T: Tapping the icon opens the COMMUNICATION SETTINGS screen.
		A double arrow indicates a field has a selectable list.

3.4

Softkeys

Description

Softkeys are selected using the relevant **F1** to **F4** function key. This chapter describes the functionality of the common softkeys used by the system. The more specialised softkeys are described where they appear in the program chapters.

Common softkey functions

Key	Description
ALPHA	To change the keypad operation to alphanumerical.
NUM	To change the keypad operation to numerical.
ALL	To start distance and angle measurements and save the measured values.
BACK	To return to the last active screen.
COORD	To open the manual coordinate entry screen.
EDM	To view and change EDM settings. Refer to "5.2 EDM Settings".
EXIT	To exit the screen or application.
MEAS	To start distance and angle measurements without saving the measured values.
OK	If entry screen: Confirms measured or entered values and continues the process. If message screen: Confirms message and continues with selected action or returns to the previous screen to reselect an option.
IR/RL	To toggle between IR and RL EDM modes.
DISPL.	To display the list of available points.
REC	To save the displayed values.
DEFLT	To reset all editable fields to their default values.
SEARCH	To search for an entered point.
VIEW	To display the coordinate and job details of the selected point.
	To display the next softkey level.

3.5

Operating Principles

Turn instrument on/off





Use the On/Off key.

Alphanumeric keypad

The alphanumerical keypad is used to enter characters directly into editable fields.

- **Numeric fields:** Can only contain numerical values. By pressing a key of the keypad the number will be displayed.
- **Alphanumeric fields:** Can contain numbers and letters. By pressing a key of the keypad the first character written above that key will be displayed. By pressing several times you can toggle through the characters. For example: 1->S->T->U->1->S...

Edit fields

-  **ESC** Deletes any change and restores the previous value.
-  Moves the cursor to the left
-  Moves the cursor to the right.
-  Inserts a character at the cursor position.
-  Deletes the character at the cursor position.



In edit mode the position of the decimal place cannot be changed. The decimal place is skipped.

Special characters

Character	Description
*	Used as wildcards in search fields for point numbers or codes. Refer to "3.6 Pointsearch".
+/-	In the alphanumeric character set "+" and "-" are treated as normal alphanumeric characters with no mathematical function.
	"+" / "-" only appear in front of an entry.

APPS 1/2

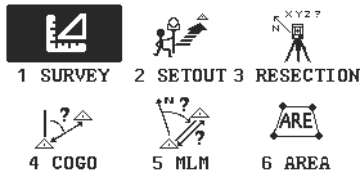

In this example selecting 2 on an alphanumeric keyboard would start the Set Out application.

3.6

Pointsearch

Description

Pointsearch is a function used by programs to find measured or known points in the memory storage.

It is possible to limit the point search to a particular job or to search the whole storage. The search procedure always finds known points before measured points that fulfil the same search criteria. If several points meet the search criteria, then the results are ordered according to the entry date. The instrument finds the most recent known point first.

Direct search

By entering an actual point number, for example 402, and pressing **SEARCH**, all points within the selected job and with the corresponding point number are found.

```
POINTSEARCH
Job:      ██████████ J101
Pt.:     ██████████ 402

Select job or enter
point coordinates manually!

SEARCH  COORD
```

SEARCH

To search for matching points within the selected job.

Wildcard search

The wildcard search is indicated by a "*". The asterisk is a place holder for any following sequence of characters. Wildcards should be used if the point number is not fully known, or to search for a batch of points.

Examples of point searches

- * All points are found.
- A All points with exactly the point number "A" are found.
- A* All points starting with "A" are found, for example, A9, A15, ABCD, A2A.
- *1 All points containing only one "1" are found, for example, 1, A1, AB1.
- A*1 All points starting with "A" and containing only one "1" are found, for example, A1, AB1, A51.

4

Operation

4.1

Instrument Setup

Description

This topic describes an instrument setup over a marked ground point using the laser plummet. It is always possible to set up the instrument without the need for a marked ground point.



Important features

- It is always recommended to shield the instrument from direct sunlight and avoid uneven temperatures around the instrument.
- The laser plummet described in this topic is built into the vertical axis of the instrument. It projects a red spot onto the ground, making it appreciably easier to centre the instrument.
- The laser plummet cannot be used with a tribrach equipped with an optical plummet.

Tripod

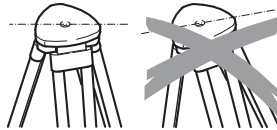

When setting up the tripod pay attention to ensuring a horizontal position of the tripod plate. Slight corrections of inclination can be made with the foot screws of the tribrach. Larger corrections must be done with the tripod legs.

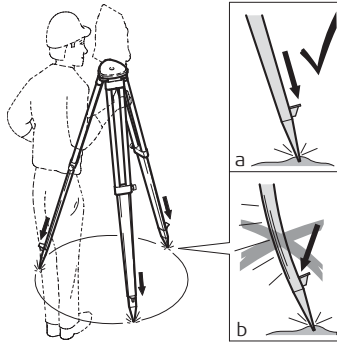

Loosen the clamping screws on the tripod legs, pull out to the required length and tighten the clamps.

- In order to guarantee a firm foothold sufficiently press the tripod legs into the ground.
- When pressing the legs into the ground note that the force must be applied along the legs.

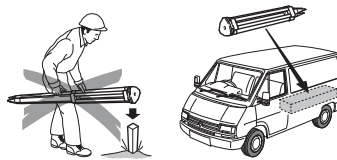

Careful handling of tripod.

- Check all screws and bolts for correct fit.
- During transport always use the cover supplied.
- Use the tripod only for surveying tasks.

Setup step-by-step

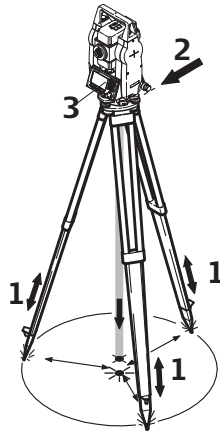

Zoom_004

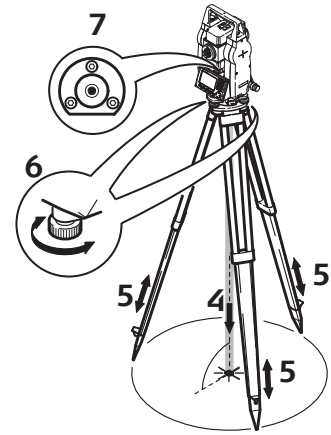

1. Extend the tripod legs to allow for a comfortable working posture. Position the tripod over the marked ground point, centring it as best as possible.
2. Fasten the tribrach and instrument onto the tripod.
3. Turn on the instrument, and, if tilt correction is set to 1- or 2-axis, the laser plummet will be activated automatically, and the **Level Up** screen appears. Otherwise, press **FNC** from within any application and select **Level**.
4. Move the tripod legs (1) and use the tribrach footscrews (6) to center the plummet (4) over the ground point.
5. Adjust the tripod legs (5) to level the circular level (7).
6. By using the electronic level, turn the tribrach footscrews (6) to precisely level the instrument. Refer to "Level up with the electronic level step-by-step".
7. Center the instrument precisely over the ground point by shifting the tribrach on the tripod plate (2).
8. Repeat steps 6. and 7. until the required accuracy is achieved.

Level up with the electronic level step-by-step

The electronic level can be used to precisely level up the instrument using the footscrews of the tribrach.

1. Turn the instrument until it is parallel to two footscrews.
2. Center the circular level approximately by turning the footscrews of the tribrach.
3. Turn on the instrument, and, if tilt correction is set to 1- or 2-axis, the laser plummet will be activated automatically, and the **Level Up** screen appears. Otherwise, press **FNC** from within any application and select **Level**.



The bubble of the electronic level appears if the instrument tilt is inside a certain levelling range.

1. Center the electronic level of the first axis by turning the two footscrews. When the electronic level is centered, the indicator on one of the electronic bubbles is centered.

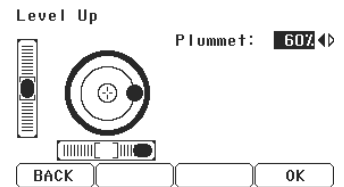

- Center the electronic level for the second axis by turning the last footscrew. When the electronic level is centered, the indicator on the second electronic bubble is centered.

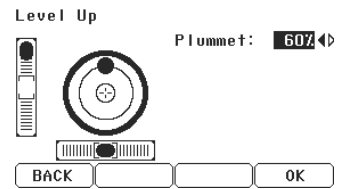

- When the electronic level is centered the instrument has been perfectly levelled up.

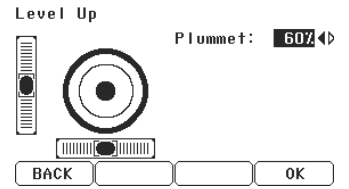

- Accept with **OK**.

Change the intensity of the laser plummet

External influences and the surface conditions may require the adjustment of the intensity of the laser plummet.

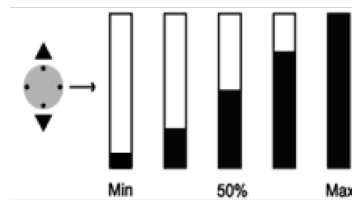

In the **Level Up** screen, adjust the intensity of the laser plummet using the navigation key. The laser can be adjusted in 25% steps as required.

Position over pipes or holes

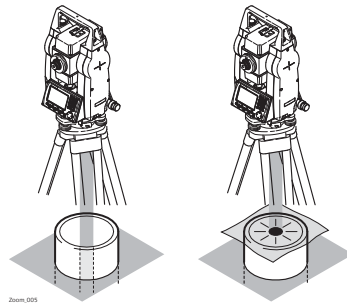

Under some circumstances the laser dot is not visible, for example over pipes. In this case, using a transparent plate enables the laser dot to be seen and then easily aligned to the center of the pipe.

4.2

Working with the Battery

Charging / first-time use

- The battery must be charged prior to using it for the first time because it is delivered with an energy content as low as possible.
- The permissible temperature range for charging is between 0°C to +40°C/+32°F to +104°F. For optimal charging we recommend charging the batteries at a low ambient temperature of +10°C to +20°C/+50°F to +68°F if possible.
- It is normal for the battery to become warm during charging. Using the chargers recommended by GeoMax, it is not possible to charge the battery if the temperature is too high.
- For new batteries or batteries that have been stored for a long time (> three months), it is effectual to make only one charge/discharge cycle.
- For Li-Ion batteries, a single discharging and charging cycle is sufficient. We recommend carrying out the process when the battery capacity indicated on the charger or on a GeoMax product deviates significantly from the actual battery capacity available.

Operation/ discharging

- The batteries can be operated from -20 °C to +55 °C/-4 °F to +131 °F.
- Low operating temperatures reduce the capacity that can be drawn; high operating temperatures reduce the service life of the battery.

Change the battery step-by-step

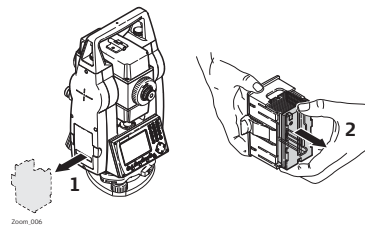

Open the battery compartment (1) and remove the battery holder.

Remove the battery from the battery holder (2).

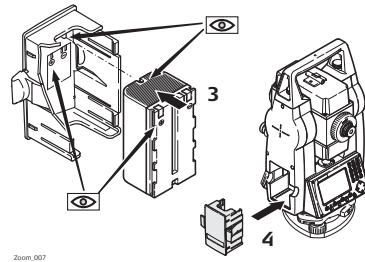

Insert the new battery into the battery holder (3), ensuring that the contacts are facing outward. The battery should click into position.

Insert the battery holder back into the battery compartment (4).



The polarity of the battery is displayed inside the battery housing.

4.3

Data Storage

Description

An internal memory is included in all instruments. The firmware stores all data in jobs in a database in the internal memory. Data can then be transferred to a computer.

For Zoom25/Zoom50 instruments, data can also be transferred from the internal memory to a computer or other device via a Bluetooth connection.

Refer to "12 Data Management" for further information on data management and data transfer.

4.4

Main Menu

Description

The **MAIN MENU** is the starting place for accessing all functionality of the instrument. It is usually displayed immediately after the **Level & Plummet** screen, after switching on the instrument.

MAIN MENU

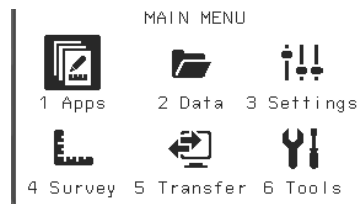

Description of the MAIN MENU functions

Function	Description
Apps	To select and start applications. Refer to "11 Applications".
Data	To manage jobs, data, codelists, formats, system memory and USB memory stick files. Refer to "12 Data Management".
Settings	To change EDM configurations, communication and general instrument settings. Refer to "5 Settings".
Survey	Survey program to begin measuring immediately. Refer to "4.5 Survey Application".
Transfer	To export and import data. Refer to "12.2 Exporting Data".
Tools	To access instrument related tools such as calibrations, personal start up settings, licence keys and system information. Refer to "6 Tools".



If desired, the instrument can be configured to start in a user defined place after the **Level & Plummet** screen, instead of the **MAIN MENU**. Refer to "6.2 Auto Start Routine".

4.5

Survey Application

Description

After switching on and setting up correctly, the instrument is immediately ready for measuring.

Access

Select **Survey** from the **MAIN MENU**.

SURVEY

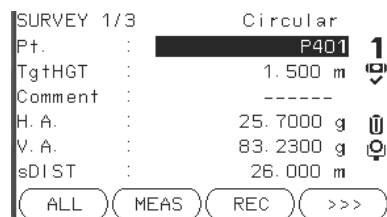

>>> CODING

To find/enter codes. Refer to "8.1 Coding".

>>> STN

To enter station data and set the station.

>>> Set HA

To set the horizontal direction orientation.

The procedure for the quick start **Survey** is identical to the procedure for the application **Survey** available under the **Apps** menu. Therefore this procedure is only described once within the application chapter. Refer to "11.2 Survey".

4.6

Distance Measurements - Guidelines for Correct Results

Description

A laser distancer (EDM) is incorporated into the instruments. In all versions, the distance can be determined by using a visible red laser beam which emerges coaxially from the telescope objective. There are two EDM modes:

- Prism measurements (P)
- Reflectorless measurements (NP)

Non-prism measurements

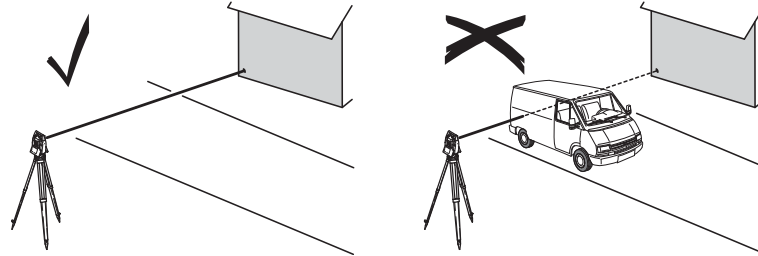

- When a distance measurement is triggered, the EDM measures to the object which is in the beam path at that moment. If a temporary obstruction, for example a passing vehicle, heavy rain, fog or snow is between the instrument and the point to be measured, the EDM may measure to the obstruction.
- Be sure that the laser beam is not reflected by anything close to the line of sight, for example highly reflective objects.
- Avoid interrupting the measuring beam while taking reflectorless measurements or measurements using reflective foils.
- Do not measure with two instruments to the same target simultaneously.

Prism measurements

- Accurate measurements to prisms should be made in IR-Default mode.
- Measurements to strongly reflecting targets such as traffic lights in Prism mode without a prism should be avoided. The measured distances may be wrong or inaccurate.
- When a distance measurement is triggered, the EDM measures to the object which is in the beam path at that moment. If for example people, cars, animals, or swaying branches cross the laser beam while a measurement is being taken, a fraction of the laser beam is reflected from these objects and may lead to incorrect distance values.
- Measurements to prisms are only critical if an object crosses the measuring beam at a distance of 0 to 30 m and the distance to be measured is more than 300 m.
- In practice, because the measuring time is very short, the user can always find a way of avoiding unwanted objects from interfering in the beam path.

WARNING

Due to laser safety regulations and measuring accuracy, using the Long Range Reflectorless EDM is only allowed to prisms that are more than 1000 m (3300 ft) away.

5

Settings

5

Applications - Getting Started

5.1

General Settings

Access

1. Select **Settings** from the **MAIN MENU**.
2. Select **General** from the **Settings** menu.
3. Press **⏮** to scroll through the screens of available settings.

GENERAL SETTINGS

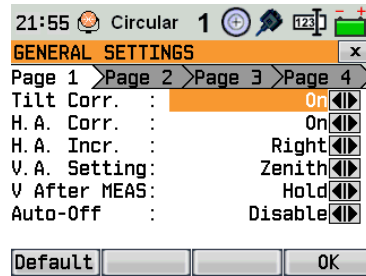

Field	Description
Tilt Corr.	<p>Off Tilting compensation deactivated.</p> <p>On Vertical angles refer to the plummet line and the horizontal directions are corrected by the standing axis tilt. For corrections depending on the HA Corr: setting, refer to the table "Tilt and horizontal corrections".</p> <p> If the instrument is used on an unstable base, for example a shaking platform or ship, the compensator should be deactivated. This avoids the compensator drifting out of it's measuring range and interrupting the measuring process by indicating an error.</p>
H.A. Corr.	<p>On Horizontal corrections are activated. For normal operation the horizontal correction should remain active. Each measured horizontal angle will be corrected, depending on the vertical angle. For corrections depending on the Tilt Corr: setting, refer to the table "Tilt and horizontal corrections".</p> <p>Off Horizontal corrections are deactivated.</p>
H.A. Incr.	<p>Right Set horizontal angle to clockwise direction measurement.</p> <p>Left Set horizontal angle to counter-clockwise direction measurement. Counter-clockwise directions are displayed but are saved as clockwise directions.</p>
V.A. Setting	<p>Sets the vertical angle.</p> <p>Zenith</p>

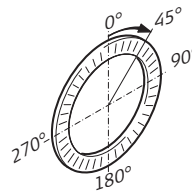

Zenith=0°; Horizon=90°.

Field	Description
-------	-------------

Horizont

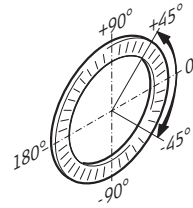

Zenith=90°; Horizon=0°.
Vertical angles are positive above the horizon and negative below it.

Slope [%]

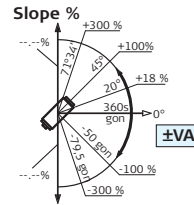



45°=100%; Horizon=0°.
Vertical angles are expressed in % with positive above the horizon and negative below it.

☞ The % value increases rapidly. ---% appears on the display above 300%.

V After MEAS		Sets if the vertical angle value recorded is the value that is displayed when MEAS or when REC is pressed. The vertical angle field in a measurement screen always shows the running angle, regardless of this setting.
	Hold	The vertical angle value that is recorded is the value that was in the vertical angle field at the time MEAS was pressed.
	Free	The vertical angle value that is recorded is the value in the vertical angle field at the time REC is pressed.
Auto-Off	Enable	The instrument switches off after 20 minutes without any activity, for example no key pressed or vertical and horizontal angle deviation is $\leq \pm 3''$.
	Disable	Automatic switch-off is deactivated. ☞ Battery discharges quicker.
Beep		The beep is an acoustic signal after each key stroke.
	Normal	Normal volume.
	Loud	Increased volume.
	Off	Beep is deactivated.
Sector Beep	On	Sector Beep sounds at right angles (0°, 90°, 180°, 270° or 0, 100, 200, 300 gon).

Field	Description	
		<ol style="list-style-type: none"> 1. No beep. 2. Fast beep; from 95.0 to 99.5 gon and 105.0 to 100.5 gon. 3. Permanent beep; from 99.5 to 99.995 gon and from 100.5 to 100.005 gon.
	Off	Sector Beep is deactivated.
Setout Beep	On	The instrument beeps when the distance from the current position to the point to be staked is ≤ 0.5 m. The closer the prism is to the point to be staked the faster the beeps will be.
	Off	Beep is deactivated.
Screen ill.	20% to 100%	Sets the screen illumination in 20% steps.
Crossh ill.	Off to 100%	Sets the illumination level of the crosshairs in 20% steps.
Heating	On	The display heater is activated.
	Off	The display heater is deactivated.
		The display heater is automatically activated when the display illumination is on and the instrument temperature is $\leq 5^{\circ}\text{C}$. This function is only available for Zoom25.
Data Output	Sets the location for data storage.	
	Int. Memory	All data is recorded in the internal memory.
	Interface	Data is recorded via the serial interface or the USB device port, depending on the port selected in the COMMUNICATION SETTINGS screen. This Data Output setting is only required if an external storage device is connected and measurements are started at the instrument with MEAS/REC or ALL. This setting is not required if the instrument is totally controlled by a data logger.
GSI-Format	Sets the GSI output format.	
	GSI 8	81..00+12345678
	GSI 16	81..00+1234567890123456
Mask	Sets the GSI output mask.	
	Mask1	Pt, HA, VA, sDIST, ppm+mm, TgtHGT, Instr.h.
	Mask2	Pt, HA, VA, sDIST, E, N, Z, TgtHGT.
	Mask3	StationID, E, N, Z, Instr.h. (Station). StationID, Ori, E, N, Z, Instr.h. (Station Result). Pt, E, N, Z (Control). Pt, HA, VA (Set Azimuth). Pt, HA, VA, SD, ppm+mm, TgtHGT, E, N, Z (Measurement).
Code Saving	Sets if the codeblock is saved before or after the measurement. Refer to "8.1 Coding".	
Language	Sets the chosen language. The current loaded language(s) are shown. A selected language can be deleted by pressing DelLng . This function is available if more than one language is installed, and the selected language is not the chosen operating language.	

Field	Description	
Lang. Choice	If multiple languages are loaded, a screen to choose the language can be shown directly after switching on the instrument.	
	On	The language screen is shown as the startup screen.
	Off	The language screen is not shown as the startup screen.
Touch Screen	Available for Color&Touch display only.	
	On	The touch screen is activated.
	Off	The touch screen is deactivated.
		Press Calib. to calibrate the touch screen. Follow the instructions on the screen.
Double PtID	Sets if multiple points are able to be recorded with the same point ID in the same job.	
	Allowed	Allows multiple points with the same point ID.
	Not Allowed	Does not allow multiple points with the same point ID.
Sort Type	Time	Lists are sorted by time of entry.
	Pt	Lists are sorted by Point IDs.
Sort Order	Descending	Lists are ordered in descending order of sort type.
	Ascending	Lists are ordered in ascending order of sort type.
Pre-/Suffix		Only used for Setout program.
	Prefix	Adds the character entered for Identifier in front of the original point number of the point to be staked.
	Suffix	Adds the character entered for Identifier at the end of the original point number of the point to be staked.
	Off	The staked point is stored with the same point number as the point to be staked.
Identifier		Only used for Setout program.
	The identifier can be up to four characters and is added at the start or end, of a point number of a point to be staked.	

Tilt and horizontal corrections

Setting		Correction			
Tilt correction	Horizontal correction	Incline longitudinal	Incline transversal	Horizontal collimation	Tilting axis
Off	On	No	No	Yes	Yes
1-Axis	On	Yes	No	Yes	Yes
2-Axis	On	Yes	Yes	Yes	Yes
Off	Off	No	No	No	No
1-Axis	Off	Yes	No	No	No
2-Axis	Off	Yes	No	No	No

5.2

EDM Settings

Description

The settings on this screen define the active EDM, **E**lectronic **D**istance **M**easurement. Different settings for measurements are available with Reflectorless (RL) and Prism (IR) EDM modes.

Access

1. Select **Settings** from the **MAIN MENU**.
2. Select **EDM** from the **Settings** menu.

EDM SETTINGS

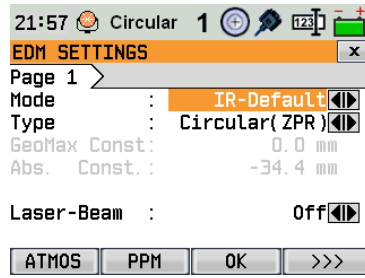

ATMOS

To enter atmospheric data ppm.

PPM

To enter an individual ppm value.

>>> **SCALE**

To enter projection scale details.

>>> **FREQ.**

To view the EDM frequency.

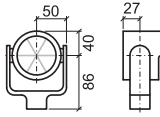
Field	Description		
Mode	IR-Default	Fine measuring mode for high precision measurements with prisms.	
	IR-Quick	Quick measuring mode with prisms, with higher measuring speed and reduced accuracy.	
	IR-Continuous	For continuous distance measurements with prisms.	
	Foil	For distance measurements using Retro reflective targets.	
	RL-Default	For distance measurements without prisms.	
	RL-Continuous	For continuous distance measurements without prisms.	
	RL-Long range	For long range distance measurements without prisms. For Zoom50 only.	
Type	Circular		Standard prism ZPR100 GeoMax Constant: 0.0 mm
	Mini-0	ZMP100	GeoMax Constant: 0.0mm
	Mini (JP)	ZPM100	GeoMax Constant: +34.4mm
	360°	ZRP1	GeoMax Constant: +23.1mm
	360°Mini	GRZ101	GeoMax Constant: +30.0mm
	Foil	ZTM100	GeoMax Constant: +34.4mm
	None	RL-modes	GeoMax Constant: +34.4mm
GeoMax Const.	This field displays the GeoMax prism constant for the selected Type : Where Type : is User1 or User2 this field becomes editable to set a user defined constant. Input can only be made in mm. Limit value: -999.9mm to +999.9mm.		
Abs. Const.	This field displays the absolute prism constant for the selected Type. When Type is User 1 or User 2 this field becomes editable to set a user defined constant. Input can only be made in mm. Limit value: -999.9 mm to +999.9 mm.		
Laser-Beam	Off	Visible laser beam is deactivated.	

Field	Description
On	Visible laser beam for visualising the target point is activated.

ATMOSPHERIC DATA ENTRY

This screen enables the entry of atmospheric parameters. Distance measurement is influenced directly by the atmospheric conditions of the air in which the measurements are taken. In order to take these influences into consideration distance measurements are corrected using atmospheric correction parameters.

The refraction correction is taken into account in the calculation of the height differences and the horizontal distance. Refer to "15.7 Scale Correction" for the application of the values entered in this screen.



When PPM=0 is selected, the GeoMax standard atmosphere of 1013.25 mbar, 12°C, and 60% relative humidity will be applied.

PROJECTION SCALE

This screen enables entry of the scale of projection. Coordinates are corrected with the PPM parameter. Refer to "15.7 Scale Correction" for the application of the values entered in this screen.

Free-PPM Entry

This screen enables the entry of individual scaling factors. Coordinates and distance measurements are corrected with the PPM parameter. Refer to "15.7 Scale Correction" for the application of the values entered in this screen.

5.3

Communication Settings

Description

For data transfer the communication parameters of the instrument must be set.

Access

1. Select **Settings** from the **MAIN MENU**.
2. Select **Comm.** from the **Settings** menu.

COMMUNICATION SETTINGS

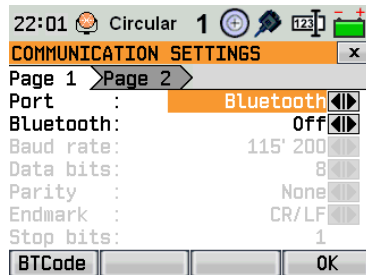

BTCode

To set a code for the Bluetooth connection.



The default Bluetooth code is '0000'.

Field	Description
Port	Instrument port.
RS232	Communication is via the serial interface.
USB	Communication is via the USB host port.
Bluetooth	Communication is via Bluetooth.
Bluetooth	On
Bluetooth	Bluetooth sensor is activated.

Field	Description
Off	Bluetooth sensor is deactivated.

The following fields are active only when **Port: RS232** is set.

Field	Description
Baud rate	Speed of data transfer from receiver to device in bits per second. 1200, 2400, 4800, 9600, 14400, 19200, 38400, 57600, 115200
Data bits	Number of bits in a block of digital data. 7 Data transfer is realised with 7 databits. 8 Data transfer is realised with 8 databits.
Parity	Even Even parity. Available if data bit is set to 7. Odd Odd parity. Available if data bit is set to 7. None No parity. Available if data bit is set to 8.
Endmark	CR/LF The terminator is a carriage return followed by a line feed. CR The terminator is a carriage return.
Stop bits	1 Number of bits at the end of a block of digital data.
Acknowledge	On Acknowledgement expected from other device after data transfer received. An error message will display if no acknowledgement is returned. Off No acknowledgement expected after data transfer.

5.4

Unit Settings

Access

1. Select **Settings** from the **MAIN MENU**.
2. Select **Unit** from the **Settings** menu.

Unit Settings

Field	Description
Angle Unit	Sets the units shown for all angular fields. <ul style="list-style-type: none"> ◦ ' '' Degree sexagesimal. Possible angle values: 0° to 359°59'59" dec. deg Degree decimal. Possible angle values: 0° to 359.999° gon Gon. Possible angle values: 0 gon to 399.999 gon mil Mil. Possible angle values: 0 to 6399.99mil.  The setting of the angle units can be changed at any time. The actual displayed values are converted according to the selected unit.
Min. Reading	Sets the number of decimal places shown for all angular fields. This is for data display and does not apply to data export or storage. For Angle Unit ◦ ' '': (0° 00' 01" / 0° 00' 05" / 0° 00' 10"). Dec.deg: (0.0001 / 0.0005 / 0.001). Gon: (0.0001 / 0.0005 / 0.001). Mil: (0.01 / 0.05 / 0.1).
Dist. Unit	Sets the units shown for all distance and coordinate related fields. <ul style="list-style-type: none"> meter Meters [m]. ft (US) US feet [ft].

Field	Description
	ft (INT) International feet [fi].
	ft-in/16 US feet-inch-1/16 inch [ft].
Dist. Decimal	Sets the number of decimal places shown for all distance fields. This is for data display and does not apply to data export or storage.
	3 Displays distance with three decimals.
	4 Displays distance with four decimals.
Temp. Unit	Sets the units shown for all temperature fields.
	°C Degree Celsius.
	°F Degree Fahrenheit.
Press.Unit	Sets the units shown for all pressure fields.
	hPa Hecto Pascal.
	mbar Millibar.
	mmHg Millimeter mercury.
	inHg Inch mercury.
Grade Unit	Sets how the slope gradient is calculated.
	h:v Horizontal: Vertical, for example 5:1.
	v:h Vertical: Horizontal, for example 1:5.
	% (v/h x 100), for example 20 %.

6

Tools

6.1

Calibration

Description

The **CALIBRATION** menu contains tools to be used for the electronic calibration of the instrument. Using these tools helps to maintain the measuring accuracy of the instrument.

Access

1. Select **Tools** from the **MAIN MENU**.
2. Select **Calib.** from the **TOOLS** menu.
3. Select a calibration option from the **CALIBRATION** screen.

Calibration options

In the **CALIBRATION** screen there are several calibration options.

Menu selection	Description
HA-Collimation	Refer to " Line-of-sight error".
Vertical Index	Refer to " Vertical index error".
Comp.Index	Refer to " Compensator index error".
View Adjustment Data	Displays the current calibration values that have been set for HA-Collimation and V-index.

6.2

Auto Start Routine

Description

Through the Auto Start tool, it is possible to record a user defined sequence of key presses so that, after switching on the instrument, a particular screen can be displayed after the **Level & Plummet** screen instead of the **MAIN MENU**. For example, the general **SETTINGS** screen for configuring the instrument settings.

Access

1. Select **Tools** from the **MAIN MENU**.
2. Select **Auto St.** from the **TOOLS MENU**.

Auto start step-by-step

1. Press **REC** in the **AUTO START** screen.
2. Press **OK** to confirm the information message and begin the recording process.
3. The next key presses are stored, up to a maximum of 16. To end the recording press **ESC**.
4. If the auto start **Status:** is set to **On**, the stored key presses will be executed automatically after switching on the instrument.



The automatic start routine has the same effect as pressing the keys manually. Certain instrument settings can not be made in this way. Relative entries such as automatically setting EDM **Mode: IR-Quick** upon switching on the instrument, are not possible.

6.3

System Information

Description

The **SYSTEM INFO** screen displays instrument, system and firmware information, as well as settings for the date and time.



Please provide the instrument-related information, such as instrument type, serial number and equipment number, as well as the firmware version and build number when contacting support.

Access

1. Select **Tools** from the **MAIN MENU**.
2. Select **SysInfo** from the **TOOLS** menu.

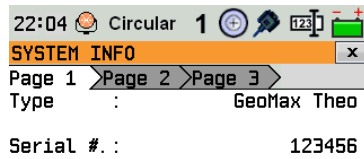

Firmw.
To display details of the firmware package installed on the instrument.

DATE
To change the date and format.

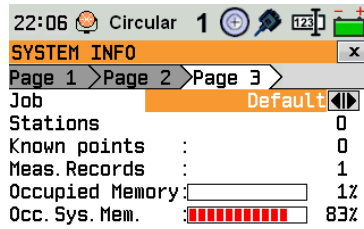

FORMAT
Formatting deletes all jobs, formats, codelists and languages. All settings are reset to default.



Before selecting **FORMAT**, to format the internal memory, ensure that all important data is first transferred to a computer. Jobs, formats, codelists, setting files, uploaded languages and firmware are deleted by formatting.

Field	Description
Type	Displays the instrument type.
Serial #	Displays the serial number of the instrument.
Instr. Temp	Displays the instrument internal temperature.
Battery	Displays the battery charging state.
Date	Displays the current date.
Time	Displays the current time.
Job	Select the job for displaying job-specific information.
Stations	Displays the number of stored stations.
Known points	Displays the known/design points within a job.
Meas. Records	Displays the number of recorded data blocks.
Occ. Job Mem.	Displays the occupied job memory space.
Occ. Sys. Mem.	Displays the occupied system memory space.

6.4

Loading Software

Description

The software can be loaded via a USB memory stick. To load the software, do the following:

Access

1. Select **Tools** from the **MAIN MENU**.
2. Select **Load FW** from the **TOOLS MENU**.



Never disconnect the power supply during the system upload process. The battery must be at least 75% capacity before commencing the upload.

Loading firmware and languages step-by-step

1. To load firmware and languages: Select **Firmware**. The **Select File** screen will appear.
To load only languages: Select **Languages only** and skip to step 4.
2. Select the firmware file from the system folder of the USB memory stick. All firmware and language files must be stored in the system folder to be transferred to the instrument.
3. Press **OK**.
4. The **Upload Languages** screen will appear displaying all language files in the system folder of the USB memory stick. Select **Yes** or **No** for a language file to be uploaded. At least one language must be set to **Yes**.
5. Press **OK**.
6. Press **Yes** on the power warning message to proceed and upload the firmware and/or selected languages.
7. Once successfully loaded, the system will shutdown and restart again automatically.

6.5

Licence Keys

Description

For all instruments, licence keys can be manually entered or uploaded.

Access

1. Select **Tools** from the **MAIN MENU**.
2. Select **Licence** from the **TOOLS** menu.

Enter licence key

Field	Description
Method	Method of licence key entry. Either Manual Entry or Upload Key File .
Key	Licence key. Available when Method: Manual Entry .



When uploading firmware from a USB memory stick, the license key file must be stored in the System folder on the USB memory stick.

6.6

Instrument Protection with PIN

Description

The instrument can be protected by a Personal Identification Number. If PIN protection is activated, the instrument will always prompt for a PIN code entry before starting up. If a wrong PIN has been entered five times, a Personal UnblockKey (PUK) code is required. This can be found on the instrument delivery papers.

Activate PIN code step-by-step

1. Select **Tools** from the **MAIN MENU**.
2. Select **PIN** from the **TOOLS** menu.
3. Activate PIN protection by setting **Use PIN-Code: On**.

4. Enter a personal PIN Code (max. 6 numerics) in the **New PIN-Code** field.
5. Accept with **OK**.



Now the instrument is protected against unauthorised use. After switching on the instrument, a PIN code entry is necessary.

Entering the PUK code

If a wrong PIN has been entered five times, the system will prompt for a Personal UnblockKey code. The PUK code can be found on the instrument delivery papers.

If the PUK code entered is correct then the instrument will start up and reset the PIN code to default value **0** and **Use PIN-Code: Off**.

Deactivate PIN code step-by-step

1. Select **Tools** from the **MAIN MENU**.
 2. Select **PIN** from the **TOOLS** menu.
 3. Enter the current PIN in **PIN-Code:**.
 4. Press **OK**.
 5. Deactivate PIN protection by setting **Use PIN-Code: Off**.
 6. Accept with **OK**.
-



The instrument is now no longer protected against unauthorised use.

7

Functions

7.1

Overview

Description

Functions can be accessed by pressing **FNC** from any measurement screen. **FNC** opens the functions menu and a function can be selected and activated.

Functions

Function	Description
Menu	Returns to the MAIN MENU .
Level	Activates the laser plummet and electronic level.
Offset	Refer to "7.2 Offset".
Del Obs	Deletes the last recorded data block. This can be either a measurement block or a code block.  Deleting the last record is not reversible! Only records recorded in Survey can be deleted.
Codes	Starts Coding application to select a code from a codelist or enter a new code. Same functionality like the softkey CODING .
RL<->IR	Changes between the two EDM modes. Available for instrument with reflectorless mode.
Laser	Activates/deactivates the visible laser beam for illuminating the target point.
EDM Con	Refer to "7.6 EDM Continuous".
DistOFF	Refer to "7.4 2 Dist. Offset".
Brg/Dis	Refer to "7.5 Brg/Dist".
Illum	Activates and deactivates the keyboard illumination light.
Display	To switch the display illumination on/off. Available for Zoom25.
Touch	To enable/disable touch functionality. Available for Zoom50.

7.2

Offset

Description

This function calculates the target point coordinates if it is not possible to set up the reflector, or to aim at the target point directly. The offset values (length, trav. and/or height offset) can be entered. The values for the angles and distances are calculated to determine the target point.

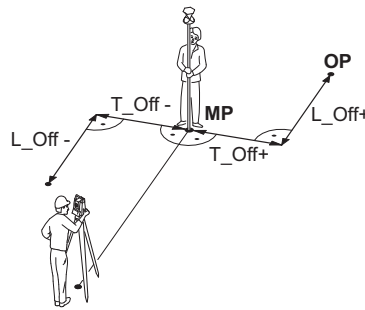

MP Measurement point
OP Offset point
L_Off Length offset
T_Off Cross offset

Access

1. Press **FNC** when within any application.
2. Select **Offset** from the **FUNCTIONS** menu.

Offset

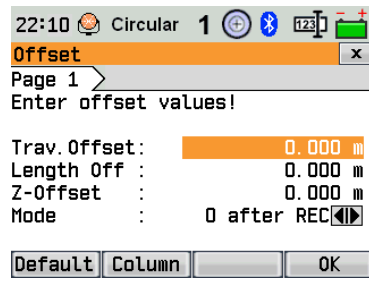

Default
To reset offset values to 0.

Column
To go to Column Offset.

Field	Description
Trav. Offset	Perpendicular offset. Positive if the offset point is to the right of the measured point.
Length Off	Longitudinal offset. Positive if the offset point is further away than the measured point.
Z-Offset	Height offset. Positive if the offset point is higher than the measured point.
Mode	Period for which the offset is to apply. <ul style="list-style-type: none"> 0 after REC The offset values are reset to 0 after the point is saved. Continuous The offset values are applied to all further measurements.
	The offset values are always reset to 0 when the application is quit.

Next step

- Press **OK** to calculate the corrected values and return to the application from which the offset function was started. The corrected angle and distances are displayed as soon as a valid distance measurement has been triggered or exists.

7.3

Column Offset

Description

Determines the coordinates of the centre point of cylindrical objects and their radius. The horizontal angle to points on both the left and right sides of the object are measured, and the distance to the object as well.

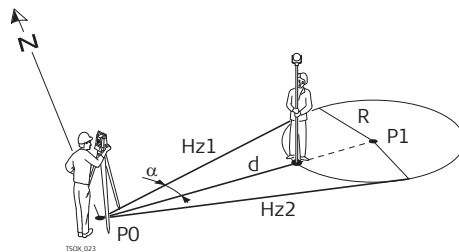

- P0 Instrument station
- P1 Centre point of cylindrical object
- H_{z1} Horizontal angle to a point on the left side of the object
- H_{z2} Horizontal angle to a point on the right side of the object
- d Distance to the object in the middle between H_{z1} and H_{z2}
- R Radius of cylinder
- α Azimuth from H_{z1} to H_{z2}

Access

Press **Column** from the **Offset** screen.

COLUMN OFFSET

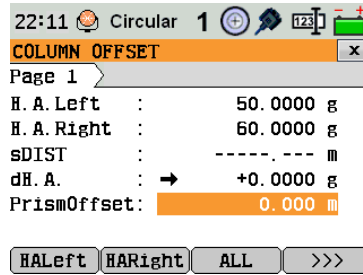

HLeft
To trigger measurement for the left side of the object.

HRight
To trigger measurement for the right side of the object.

Field	Description
H.A. Left	Measured horizontal direction to the left side of the object. Using the verticalhair, aim at the left side of the object, then press HLeft .
H.A. Right	Measured horizontal direction to the right side of the object. Using the verticalhair, aim at the right side of the object, then press HRight .
dH.A.	Deviation angle. Rotate the instrument to aim in the direction of the centre point of the cylindrical object, such that dH.A. is zero.
PrismOffset	Prism offset distance between the centre of the prism and the surface of the object to be measured. If the EDM mode is Non-Prism, the value is set to zero automatically.

Next step

Once **dH.A.** is zero, press **ALL** to complete the measurement and display the results.

COLUMN OFFSET RESULT

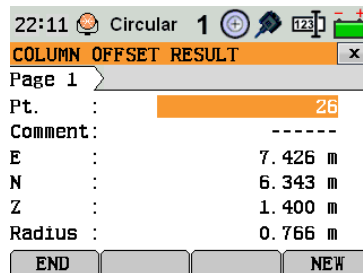

END
To record results and return to the main **Offset** screen.

NEW
To measure a new cylindrical object.

Field	Description
Pt.	Defined point ID of the centre point.
E	Easting coordinate of the centre point.
N	Northing coordinate of the centre point.
Z	Height of the point measured with the reflector.  This is not the calculated height of the centre point.
Radius	Radius of the cylinder.

7.4

2 Dist. Offset

Description

This function is used for measurements to a point that is not directly visible, using a special 2 Dist. Offset pole.

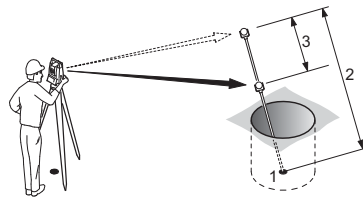

- 1 E, N, Z of target point
- 2 Pole length
- 3 Distance P1-P2

Access

1. Press **FNC** when within any application.
2. Select **2 Dist. Offset** from the **FUNCTIONS** menu.

Next step

If required, press **POLE** to define the pole or EDM settings.

POLE SETTINGS

Field	Description
Mode	Changes the EDM Mode.
Type	Changes the prism type.
GeoMax Const	Displays the prism constant.
Pole Length	Total length of 2 Dist. Offset pole
Dist. P1-P2	Spacing between the centers of the prisms P1 and P2.
Meas. Tol	Limit for the difference between the given and measured spacing of the prisms. If the tolerance value is exceeded, the function will issue a warning.

Next step

In the **2 DIST. OFFSET** screen, measure to the first and second prisms using **ALL** and the **2 DIST. OFFSET RESULT** screen is displayed.

2 DIST. OFFSET RESULT

Displays Easting, Northing and Height coordinates of the target point.

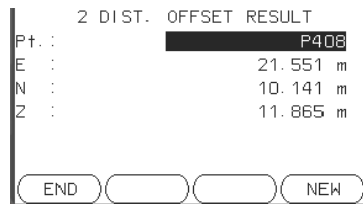

END
To record results and return to application where **FNC** was selected.

NEW
To return to the **2 DIST. OFFSET** screen.

Next step Press **END** to return to the application where **FNC** was selected.

7.5 Brg/Dist

Description This function calculates and displays the slope and horizontal distance, height difference, azimuth, grade, and coordinate differences between the last two measured points. Valid distance measurements are required for the calculation.

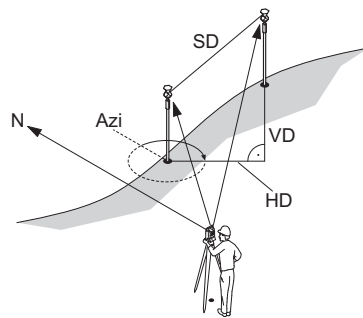

Azi Azimuth
SD Slope distance
VD Height distance
HD Horizontal distance

- Access**
1. Press **FNC** when within any application.
 2. Select **Brg/Dist** from the **FUNCTIONS** menu.

CONTROL DISTANCE

Field	Description
Brg	Difference in bearing between the two points.
Grade	Difference in gradient between the two points.
hDIST	Difference in horizontal distance between the two points.
sDIST	Difference in slope distance between the two points.
d.d.Z	Difference in height between the two points.

Messages The following are important messages or warnings that may appear.

Messages	Description
Less than two valid measurements!	The values cannot be calculated as there are less than two valid measurements.

Next step

Press **OK** to return to the application where **FNC** was selected.

7.6**EDM Continuous****Description**

This function activates or deactivates the tracking measurement mode. The new setting is displayed for about one second and then set. The function can only be activated from within the same EDM mode and prism type. The following options are available.

Mode	Off <=> On
IR	IR-Default <=> IR-Continuous / IR-Quick <=> IR-Continuous.
RL	RL-Default <=> RL-Continuous.



The last active measurement mode remains set when the instrument is switched off.

8

Coding

8.1

Coding

Description

Codes contain information about recorded points. With the help of coding, points can be assigned to a particular group simplifying later processing.

Codes are stored in codelists, with each codelist supporting a maximum of 200 codes.

GSI coding

Codes are always stored as free codes (WI41-49), that means that codes are not directly linked to a point. They are stored before or after the measurement depending on the setting made.

A code is always recorded for each measurement as long as the code is displayed in the **Code:** field. For a code not to be recorded, the **Code:** field must be cleared. This can be set to occur automatically. Refer to "5.1 General Settings".

Access

- Either, select **Survey** from the **MAIN MENU** and press >>> **CODING**.
- Or, press **FNC** when within any application and select **Code Library**.

CODE-LIBRARY

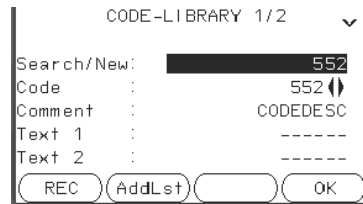

REC

To record the code without measurement.

AddLst

To add the entered code to the codelist.

Field	Description
Search/New	Code name. After entry, the firmware searches for a matching code name, and displays these in the code field. If a matching code name does not exist this value becomes the new code name.
Code	List of existing code names.
Comment	More remarks.
Text1 to Text8	More information lines, freely editable. Used to describe attributes of the code.

Extend / edit codes

To each code a description and a maximum of 8 attributes with up to 16 characters each can be assigned. Existing code attributes, displayed in fields **Text 1:** to **Text 8:**, can be overwritten freely with the following exceptions:

The codelist editor of GGO can assign a status to the attributes.

- Attributes with status "fixed" are write-protected. They cannot be overwritten or edited.
- For attributes with status "Mandatory" an input or a confirmation is required.
- Attributes with status "Normal" can be edited freely.

8.2

Rapid Coding

Availability

Only available on Zoom50.

Description

Using rapid coding, a predefined code can be called directly via the keypad on the instrument. The code is selected by entering a two-digit number, the measurement is then triggered and the measured data and code saved.



A total of 99 rapid codes can be assigned.

The rapid code number can be assigned when the code is created in the **Coding** screen, in the Codelist Manager in GGO, or it is assigned in accordance with the order in which the codes were entered, for example, 01 -> first code in the code list ... 10 -> tenth code in the code list.

Access

1. Select **Apps** from the **MAIN MENU**.
2. Select **SURVEY** from the **Apps** Menu.
3. Press  **R-Code**.

Rapid coding step-by-step

1. Press  **R-Code**.
2. Enter a two-digit number on the keypad.
 A two-digit code must always be entered on the keypad even if only a one-digit code was assigned.
For example: 4 -> enter 04.
3. The code is selected, the measurement triggered and the measured data and code saved. The name of the selected code is displayed after the measurement.
4. Press  **R-Code** again to end rapid coding.

Messages

The following are important messages or warnings that may appear.

Messages	Description
Cannot edit attribute!	Attribute with fixed status cannot be changed.
No codelist available!	No codelist in memory. Manual input for code and attributes are called automatically.
Code not found!	No code is assigned to the entered number.

GGO

Codelists can be easily created and uploaded to the instrument using the supplied GGO software.

9 MapView Interactive Display Feature

9.1 Overview

Availability Only available on Zoom50.

Description MapView is an display feature embedded in the firmware. MapView provides a graphical display of the survey elements which allows for a better overall understanding of how the data being used and measured relates to each other.

9.2 Accessing MapView

Description The MapView interactive display feature is provided as a page within applications. It is accessed through the application itself. Depending on the application and from where in the application MapView is accessed, different MapView modes are available.

Access **To view points on a map:**

- In **R-SURVEY/SURVEY** change to page **4/5**.
- In **Apps** press the softkey **>>> MAP**.

9.3 MapView Components

9.3.1 Screen Area

Standard screen

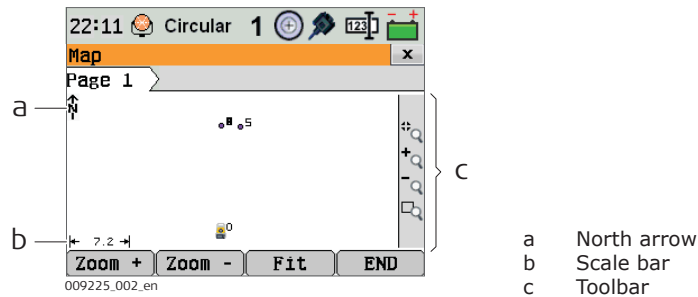

- a North arrow
- b Scale bar
- c Toolbar

Scale bar

Symbol	Description
	Scale of the current screen. The minimum is 0.1 m. There is no maximum for the zoom but the scale cannot display values greater than 99000 m. In this case the value displayed will be >99000 m.

North arrow

Symbol	Description
	North arrow. North is always orientated towards the top of the screen.

Toolbar

Symbol	Description
	Icon toolbar. Refer to "9.3.2 Keys, Softkeys and Toolbar" for more information about the functionality of the icons in the toolbar.

Instrument station

Symbol	Description
	Position of the instrument station. The orientation of the instrument is shown as dotted line.

9.3.2

Keys, Softkeys and Toolbar

Description





Standard functionality is provided by softkeys, keys and a toolbar within MapView.

The softkeys are available regardless of the mode in which MapView was accessed and always perform the same functions.

On the right side of the screen, a toolbar with icons is available. Some functions of the toolbar can also be performed by using a softkey or key instead. Refer to the following table for a description of the toolbar functions and their respective softkey/key equivalents, if available.

Overview of keys, softkeys and icons

The softkeys described in this table are standard on all MapView screens. For descriptions of mode-specific softkeys, see appropriate chapters.





Icon	Key or Softkey	Description
	Fit	The fit icon fits all displayable data, according to filters and the map configuration, into the screen area, using the largest possible scale.
	Zoom +	To zoom into the map.
	Zoom -	To zoom out of the map.
	-	The windowing icon zooms to a specified area window. An area window can be drawn by dragging the stylus on the screen in a diagonal line to make a rectangular area or by tapping twice on the screen to define diagonally opposite corners of a rectangular area. This action causes the screen to zoom to the selected area.

Icon	Key or Softkey	Description
-	Tap on screen with stylus, hold and move OR Left/right/up/down arrow key	To move the view of a map up and down as well as left and right. This is particularly useful when you have zoomed in on a view, and want to move the view around to see other areas of interest.

9.3.3

Point Symbols

Symbols

Sym- bol		Description
B&W	C&T	
		Known point.
		Calculated station
		Measured point.

10

Applications - Getting Started

10.1

Overview

Description

Applications are predefined programs, that cover a wide spectrum of surveying duties and facilitate daily work in the field. The following applications are available, although application packages for each instrument may vary from the programs stated in the following list:

- Survey
- Setout
- Resection
- Missing Line Measurement
- COGO
- Area & Volume
- Remote Elevation
- Reference line
- Reference arc
- Construction
- Road 2D
- Road 3D
- Traverse

10.2

Starting an Application

Access

1. Select **Apps** from the **MAIN MENU**.
2. Press **8** to move through the screens of available applications.

Pre-settings screens

Pre-settings for Survey is shown as an example. Any additional settings for particular applications are explained within the chapters for those applications.

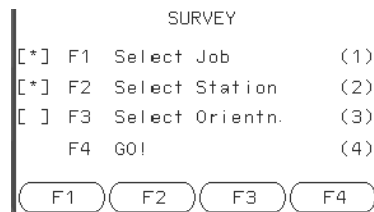

- [•] Setting has been made.
- [] Setting has not been made.
- F1-F4** To select menu item.

Field	Description
Select Job	To define the job where data will be saved. Refer to "10.3 Selecting the Job".
Stationing	To define the current position of the instrument station. Refer to "10.4 Selecting the Station".
Go!	Starts the selected application.

10.3

Selecting the Job

Description

All data is saved in Jobs, like file directories. Jobs contain measurement data of different types, for example measurements, codes, known points, or stations. Jobs are individually manageable and can be exported, edited or deleted separately.

Access

Select **Select Job** in **Pre-settings** screen.

SELECT JOB

```

SELECT JOB 1/3
Job :      J101
User:      ABC
Date:      24. 03. 2010
Time:      14: 47: 54
NEW      OK
    
```

NEW
To create a new job.

Field	Description
Job	Name of an existing job to be used.
User	Name of user, if entered.
Date	Date the selected job was created.
Time	Time the selected job was created.

Next step

- Either, press **OK** to continue with the selected job.
- Or, press **NEW** to open the **NEW JOB** screen and create a new job.

Recorded data

Once a job is set up, all subsequent recorded data will be stored in this job.

If no job was defined and an application was started, or if in **Survey** and a measurement was recorded, then the system automatically creates a new job and names it "DEFAULT".

Next step

Press **OK** to confirm the job and return to the **Pre-Settings** screen.

10.4

Selecting the Station

Description

All measurements and coordinate computations are referenced to the set station coordinates.

The station coordinates that are set must include:

- at least grid coordinates (E, N), and
- the station height, if required.

The coordinates can be entered manually or selected from the memory.

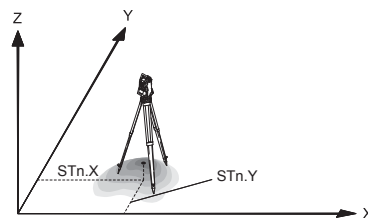

Directions

X Easting
Y Northing
Z Height

Station coordinates

Stn.X Easting coordinate of station
Stn.Y Northing coordinate of station

Access

Select **Select Station** in the **Pre-settings** screen.

Station input

Field	Description
Stn	Station name of a previously saved station position.



If no station was set and an application was started, or if in **Survey** and a measurement was recorded, then the last station is set as the current station.

Next step

The **Inst.H.** field appears once the station coordinates have been entered. Enter the instrument height if desired and press **OK** to return to the **Pre-Settings** screen.

10.5 Selecting the Orientation

10.5.1 Overview

Description

All measurements and coordinate computations are referenced to the orientation of the set station. The orientation can be entered manually or determined from points that are either measured or selected from the memory.

Access

Select **Select Orientn.** in the **Pre-settings** screen and choose:

- **Angle** To enter a new bearing. Refer to "10.5.2 Manual Orientation".
- **Coordinates** To calculate and set the orientation using existing coordinates. A maximum of five target points can be used. Refer to "10.5.3 Orientation with Coordinates".

10.5.2 Manual Orientation

Access

Select **Angle** in the **STN.ORIENTATION** screen.

MANUAL ANGLE SETTING

```
MANUAL ANGLE SETTING
Brg. : 0.0000 g
TgtHGT: 1.500 m
BS ID : 301
[ALL] [REC] [H. A. =0] [EDM]
```

HA=0 To set **Brg:** 0

Field	Description
Brg	Horizontal direction of the station.
TgtHGT.	Height of the reflector.
BS ID	Point ID of the backsight point.

Next step

- Either, press **ALL** to measure and record the distance and horizontal angles. This will calculate and set the orientation and return to the **Pre-Settings** screen.
- Or, press **REC** to record the horizontal direction only. This will set the orientation and return to the **Pre-Settings** screen.

10.5.3

Orientation with Coordinates

Diagram

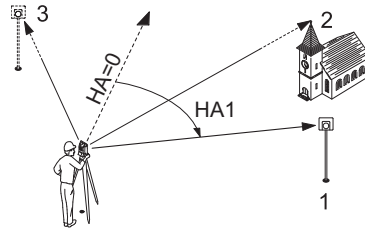

Known coordinates

- 1 Target point
- 2 Target point
- 3 Target point

Calculations

- HA1 Station orientation

Access

Select **Coordinates** in the **STN-ORIENTATION** screen.

Orientation with coordinates

Field	Description
Pt.	Point ID of the backsight point.

Next step

Find an existing backsight point in the pointsearch or enter ENZ coordinates for a new point. Press **OK** to continue to **Sight target point**.

Sight target point

Field	Description
BS ID	Point ID of the selected, or entered backsight point.

Next step

After each measurement the message, **Do you want to take additional measurements** appears. Selecting:

- **Yes** returns to the **Sight target point** screen to take an additional measurement. A maximum of five target points can be used.
- **No** proceeds to the **STN. ORIENTATION RESULT** screen.

Result calculation

If more than one target point is measured then the orientation is computed using the "least squares method".

IF	THEN
the orientation is only measured in face II	the horizontal direction is based on face II.
the orientation is measured only in face I or a mixture of I and II	the horizontal direction is based on face I.
a target point is measured several times in the same face	the last valid measurement is used for the computation.

Stn. Orientation result

Field	Description
Pts	Number of points used in the calculation.
Stn	Station name for which the orientation has been set.

Field	Description
HA Corr	Horizontal correction
Std.Dev	Standard deviation indicating the potential variance between the true orientation and that calculated.

Next step

- Either, press **Resid** to display the residuals.
- Or, press **OK** to set the orientation and return to the **Pre-Settings** screen.

Stn. Orientation Residuals

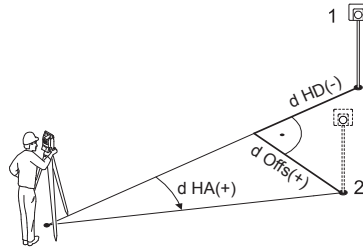

1	Actual
2	Design
P2	Target point
d Offs	Height correction
d HD	Correction in horizontal distance
d HA	Correction in horizontal direction

Field	Description
BS ID	Point IDs of the target points used in calculating the orientation.
d.H.A	The difference in horizontal direction to the target point.
d.H.D	The difference in horizontal distance to the target point.
dZ	The difference in height to the target point.



If no orientation was set and an application was started, or if in **Survey** and a measurement was recorded, then the current horizontal direction is set as the orientation.

Next step

Select **GO!** to begin the application.

11

Applications

11.1

Common Fields

Description of fields

The following table describes common fields that are found within the firmware applications. These fields are described here once and not repeated in the application chapters unless the field has a specific meaning within that application.

Field	Description
Pt, Pt 1	Point ID of the point.
TgtHGT	Height of the reflector.
HA	Horizontal direction to the point.
VA	Vertical angle to the point.
hDIST	Horizontal distance to the point.
sDIST	Slope distance to the point.
dHGT	Vertical distance to the point.
E	Easting coordinate of the point.
N	Northing coordinate of the point.
Z	Height coordinate of the point.

11.2

Survey

Description

Survey is an application used for the measurement of an unlimited number of points. It is comparable to **Survey** from the **MAIN MENU**, but includes pre-settings for the job, station and orientation prior to beginning a survey.

Access

1. Select **Apps** from the **MAIN MENU**.
2. Select **SURVEY** from the **Apps** menu.
3. Complete application pre-settings. Refer to "5 Applications - Getting Started".

SURVEY

The screenshot shows the SURVEY application interface. It displays several fields: Pt (P401), TgtHGT (1.500 m), Comment (-----), H. A. (25.7000 g), V. A. (83.2300 g), and sDIST (26.000 m). There are navigation buttons at the bottom: ALL, MEAS, REC, and >>>. To the right of the fields, there are instructions: '>>> I Pt' (To switch between individual and current point numbers) and '>>> CODING' (To find/enter codes. Refer to "8.1 Coding").

Field	Description
Comment / Code	Comment or Code name depending on the coding method. Two coding methods are available: <ol style="list-style-type: none">1. Comment coding: This text is stored with the corresponding measurement. The code is not related to a codelist, it is just a simple comment. A codelist on the instrument is not necessary.2. Expanded coding with codelist: Press >>> CODING. The code that was entered is searched for within the code list and it is possible to add attributes to the code.

Next step

- Either, press **ALL** to record another point.
- Or, press **ESC** to exit the application.

11.3

Set Out

Description

Set Out is an application used to place marks in the field at predetermined points. These predetermined points are the points to be staked. The points to be staked may already exist in a job on the instrument, or be manually entered.

The application can continuously display differences, between current position and desired set out position.

Set Out modes

Points can be staked using different modes: Polar mode, Orthogonal to station mode and Cartesian mode.

Polar Set Out mode

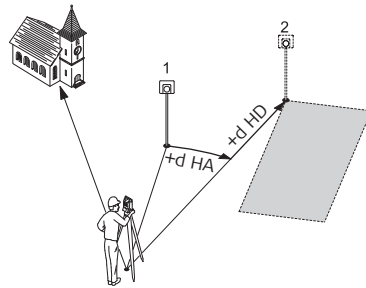

- 1 Current position
- 2 Point to be set out
- dHD Longitudinal offset: positive if point to be setout is further away.
- dHA Angle offset: positive if point to be setout is to the right of the actual direction.

Orthogonal to Station Set Out mode

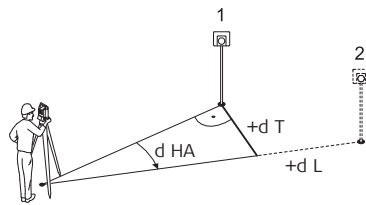

- 1 Current position
- 2 Point to be set out
- dL Longitudinal offset: positive if nominal point is further away.
- dT Transversal offset, perpendicular to line-of-sight: positive if nominal point is to the right of the measured point.
- dHA Angle offset: positive if nominal point is to the right of the actual direction.

Cartesian Set Out mode

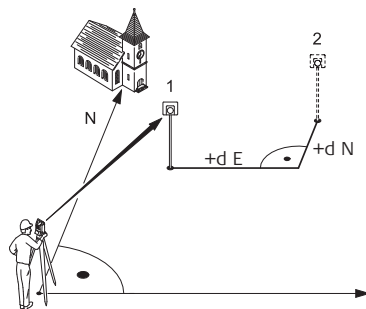

- 1 Current position
- 2 Point to be set out
- d E Easting offset between point to be set out and actual point.
- d N Northing offset between point to be set out and actual point.

Access

1. Select **Apps** from the **MAIN MENU**.
2. Select **SETOUT** from the **Apps** menu.
3. Complete application pre-settings. Refer to "5 Applications - Getting Started".

SET OUT

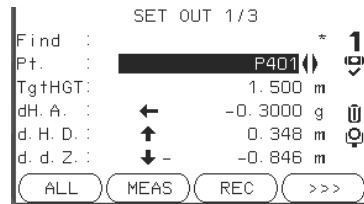

>>> **MANUAL**

To manually enter coordinates of a point.

>>> **B&D**

To enter the direction and horizontal distance to a set out point.



Press  to move through the pages. The bottom three measurement fields on the screen will change for the Polar, Orthogonal or Cartesian modes.

Field	Description
Find	Value for Point ID search. After entry, the firmware searches for matching points, and displays these in Pt : If a matching point doesn't exist the pointsearch screen opens.
d HA	Angle offset: Positive if set out point is to the right of the measured point.
d.H.D	Horizontal offset: Positive if set out point is further away than the measured point.
d.d.Z	Height offset: Positive if set out point is higher than the measured point.
dLength	Longitudinal offset: Positive if set out point is further away than the measured point.
dTrav.	Perpendicular offset: Positive if set out point is to the right of the measured point.
dE	Easting offset: Positive if set out point is to the right of the measured point.
dN	Northing offset: Positive if set out point is further away than the measured point
dZ	Height offset: Positive if set out point is higher than the measured point.

Next step

- Either, press **ALL** to record measurements for a set out point.
- Or, press **ESC** to exit the application.

11.4

Resection

11.4.1

Starting Resection

Description

Resection is an application used to determine the instruments position from measurements to known points. A minimum of 2 known points and a maximum of 10, can be used to determine the position.

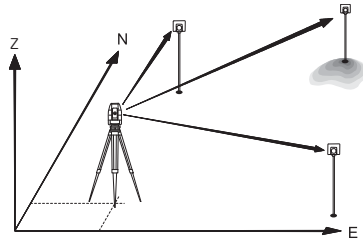

Access

1. Select **Apps** from the **MAIN MENU**.
2. Select **RESEC** from the **Apps** menu.
3. Complete application pre-settings. Refer to "10.2 Starting an Application".
4. **Select Accuracy Limit:**
 1. **Status: On** to activate a warning message if the calculated standard deviation exceeds the limit.
 2. Set the accuracy limits for the Easting, Northing and Height coordinates and the standard deviation angle.
 3. Press **OK** to save the limits and return to the **Pre-settings** screen.
5. Select **GO!** to begin the application.

Enter target data

Enter the name of the station and the height of the instrument in the **Station data** screen and press **OK**.

Next step

To access the **Sight target point** screen:

- Either, press **OK** after entering the target data fields in the **Target data** screen.

Sight target point

In the **Sight target point** screen:

		2 / 1	
Pt. :	P404		2
TgtHGT:	1.500 m		
H. A. :	302.6000 g		
V. A. :	287.2000 g		
hDIST :	31.355 m		
<input type="button" value="ALL"/> <input type="button" value="NextPt"/> <input type="button" value="CALC."/> <input type="button" value=">>>"/>			

Next step

Press **ALL** or **MEAS/REC** to measure the next known point.

11.4.2

Measuring Information

Measurement sequences

The following measurement sequences are possible:

- Horizontal direction and vertical-angles only (resection)
- Distance and horizontal direction and vertical-angle
- Horizontal direction and vertical-angles to some point(s) and horizontal direction and vertical angles plus distance to other point(s).

Single face I, single face II, or dual face I and II measurements are always possible. No specific point sequence or specific face sequences are required.

Dual face measurements

When measuring the same target in both faces, the reflector height may not be changed when observing in the second face. Error checks are made for dual face measurements to ensure the same point is sighted with the other face.



If a target point is measured several times in the same face, only the last valid measurement is used for computation.

Measurements not included in computations

Target points with 0.000 height are discarded for height processing. If a target point has a valid height of 0.000 m, use 0.001 m to include it for height processing.

11.4.3

Computation Procedure

Description

The measuring procedure automatically determines the method of evaluation, for example resection or three point resection.

If more than the minimum required measurements are performed, the procedure uses a least squares adjustment to determine the 3D position and averages orientation and height measurements.

- The original averaged face I and face II measurements are used for the computation process.
- All measurements are treated with the same accuracy, whether these are measured in single or dual face.
- Easting and Northing are determined by the least squares method, which includes standard deviation and improvements for horizontal direction and horizontal distances.
- The final height (Z) is computed from averaged height differences based on the original measurements.
- The horizontal direction is computed with the original averaged face I and face II measurements and the final computed plan position.

11.4.4

Resection Results

Access

Press **COMPUTE** from the **STATION SETUP RESULT** screen after at least two points and a distance have been measured.

STATION COORDINATES

This screen displays calculated station coordinates. The final computed results are Easting, Northing and Height coordinates of the present instrument station, including the instrument height.

Standard deviations and residuals for accuracy assessments are provided.

STATION COORDINATES	
Stn :	S201
Inst. H :	1.400 m
Stn. E :	-0.000 m
Stn. N :	-0.000 m
Stn. Z :	0.000 m

BACK RESID StdDev OK

- AddPt** To return to the **TARGET POINT ENTRY** screen to enter the next point.
- Resid.** To display residuals and to define the use of points as 1D, 2D or 3D. Refer to Target Residuals.
- Std.Dev** To display the standard deviation of the station coordinates and orientation.
- SET** To set the station coordinates and/or orientation.



If the instrument height was set to 0.000 in the setup screen, then the station height refers to the height of the tilting axis.

Field	Description
Stn	Current station ID.
Inst.H	Current instrument height.

Field	Description
E	Calculated Easting coordinate of the station.
N	Calculated Northing coordinate of the station.
Z	Calculated Height coordinate of the station.
H.A.	Current Hz angle with the new orientation.

Next step

Press **RESID** to display the target residuals.

Target Residuals

The **Target Residuals** screen displays the computed residuals for the horizontal and vertical distances and the horizontal direction. Residual = Calculated value - Measured value.

Use indicates if and how a target point is used in the station calculation. Choices are **3D**, **2D**, **1D** and **Off**.

Description of fields

Field	Description
3D	Easting, Northing and Height coordinates are used for the calculation.
2D	Easting and Northing coordinates are used for the calculation.
1D	Only the height of the point is used for the calculation.
Off	The point is not used for the calculation.

Messages

The following are important messages or warnings that may appear.

Messages	Description
Selected point has invalid data! Check data and try again!	This message occurs if the selected target point has no Easting or Northing coordinate.
Max. 10 points supported!	10 points have already been measured and another point is selected. The system supports a maximum of 10 points.
No position computed due to bad data!	The measurements may not allow final station coordinates (Eastings, Northings) to be computed.
No height computed due to bad data!	Either the target height is invalid or insufficient measurements are available to compute a final station height.
Face I/II mismatch!	This error occurs if a point was measured in one face and the measurement in the other face differs by more than the specified accuracy limit for the horizontal or vertical angle.
No data measured! Measure point again!	There is insufficient data measured to be able to compute a position or height. Either there are not enough points used or no distance measured.

Next step

Press **Set** to set the station coordinates and/or orientation and return to the **Programs Menu**.

11.5

Missing Line Measurement

Description

Missing Line Measurement is an application used to compute slope distance, horizontal distance, height difference and azimuth of two target points which are either measured, selected from the memory, or entered using the keypad.

Missing Line Measurement methods

The user can choose between two different methods:

- Polygonal: P1-P2, P2-P3, P3-P4.
- Radial: P1-P2, P1-P3, P1-P4.

Polygonal method

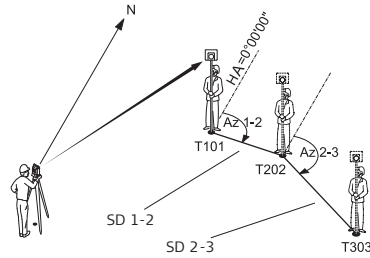

T101 1st target point
 T202 2nd target point
 T303 3rd target point
 SD 1-2 Slope distance from T101-T202
 SD 2-3 Slope distance from T202-T303
 Az 1-2 Azimuth from T101-T202
 Az 2-3 Azimuth from T202-T303

Radial method

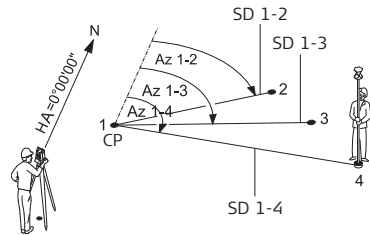

1-4 Target points
 SD 1-2 Slope distance from 1-2
 SD 1-3 Slope distance from 1-3
 SD 1-4 Slope distance from 1-4
 Az 1-2 Azimuth from 1-2
 Az 1-3 Azimuth from 1-3
 Az 1-4 Azimuth from 1-4
 CP Center point

Access

1. Select **Apps** from the **MAIN MENU**.
2. Select **MLM** from the **Apps** menu.
3. Complete application pre-settings. Refer to "5 Applications - Getting Started".
4. Select **Polygonal** or **Radial**.

Missing line measurements

After completing the measurements required, the **MLM RESULT** screen will appear.

MISSING LINE RESULT - Polygonal method

```
MISSING LINE RESULT
Pt 1 : 415
Pt 2 : 416
Brg. : 136.9985 g
Grade : 1.000: 0.029 h:v
d.H.D.: 3.532 m
d.S.D.: 3.533 m
d.d.z.: 0.104 m
NewPt1 NewPt2  RADIAL
```

NewPt 1

To calculate an additional line. Application starts again at point 1.

NewPt 2

To set point 2 as the starting point of a new line. A new point 2 must be measured.

RADIAL

To switch to radial method.

Field	Description
Brg	Azimuth between point 1 and point 2.
Grade	Grade [%] between point 1 and point 2.
d.H.D	Horizontal distance between point 1 and point 2.
d.S.D	Slope distance between point 1 and point 2.
d.d.Z	Height difference between point 1 and point 2.

Next step

Press **ESC** to exit the application.

11.6

COGO

11.6.1

Starting

Description

COGO is an application used to perform **coordinate geometry** calculations such as, coordinates of points, bearings between points and distances between points.

Access

1. Select **Apps** from the **MAIN MENU**.
2. Select **COGO** from the **APPS** menu.
3. Complete application pre-settings. Refer to "5 Applications - Getting Started".
4. Select from the **COGO** menu:

Application	Description
Inverse	Inverse.
Traver.	Traverse.
Brg-Brg	Bearing-Bearing.
Brg-Dst	Bearing-Distance.
Dst-Dst	Distance-Distance.
Ln-Ln	Line intersection.
DistOff	Distance offset
Set Pt	Set point by distance offset
Plane	Plane offset.
Line-Ex	Line extension.

11.6.2

Inverse and Traverse

Access

Select **Inverse** or **Traver.** from the **COGO** menu.

Inverse

Use the inverse subapplication to calculate the distance, direction, height difference and grade between two known points.

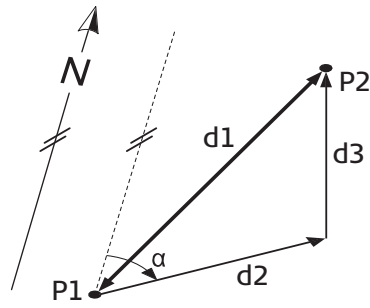

Known

- P1 First known point
- P2 Second known point

Unknown

- α Direction from P1 to P2
- d1 Slope distance between P1 and P2
- d2 Horizontal distance between P1 and P2
- d3 Height difference between P1 and P2

Traverse

Use the traverse subapplication to calculate the position of a new point using the bearing and the distance from a known point. Offset optional.

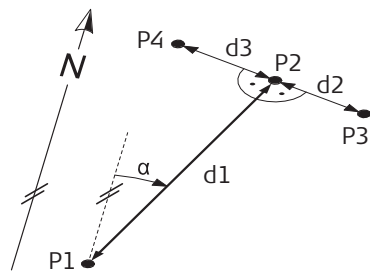

Known

- P1 Known point
- α Direction from P1 to P2
- d1 Distance between P1 and P2
- d2 Positive offset to the right
- d3 Negative offset to the left

Unknown

- P2 COGO point without offset
- P3 COGO point with positive offset
- P4 COGO point with negative offset

11.6.3

Intersections

Access

Select the desired COGO method from the **COGO** menu.

- **Brg-Brg**
- **Dst-Dst**
- **Brg-Dst**
- **Ln-Ln**

Bearing-Bearing

Use the bearing-bearing subapplication to calculate the intersection point of two lines. A line is defined by a point and a direction.

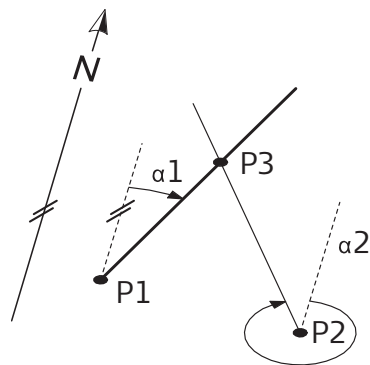

Known

- P1 First known point
- P2 Second known point
- $\alpha1$ Direction from P1 to P3
- $\alpha2$ Direction from P2 to P3

Unknown

- P3 COGO point

Bearing-Distance

Use the bearing-distance subapplication to calculate the intersection point of a line and a circle. The line is defined by a point and a direction. The circle is defined by the center point and the radius.

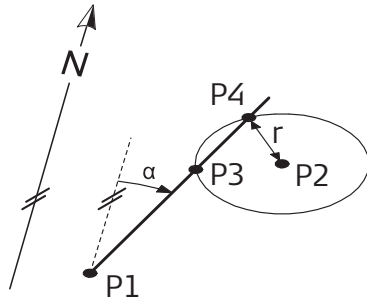

Known

- P1 First known point
- P2 Second known point
- α Direction from P1 to P3 and P4
- r Radius, as the distance from P2 to P4 or P3

Unknown

- P3 First COGO point
- P4 Second COGO point

Distance-Distance

Use the distance-distance subapplication to calculate the intersection point of two circles. The circles are defined by the known point as the center point and the distance from the known point to the COGO point as the radius.

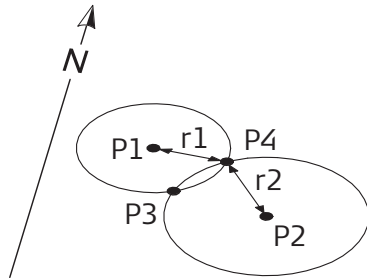

Known

- P1 First known point
- P2 Second known point
- r1 Radius, as the distance from P1 to P3 or P4
- r2 Radius, as the distance from P2 to P3 or P4

Unknown

- P3 First COGO point
- P4 Second COGO point

By Points

Use the line-line subapplication to calculate the intersection point of two lines. A line is defined by two points.

To add a shift to the lines do the following:

1. Select **Page 2** (Colour & Touch display) or **Page 2/2** (Black & White display) from the **INTERSECTION 4 POINTS** screen.
2. Enter the values to shift the lines. Enter a positive value (+) to shift the line to the right side. Enter a negative value (-) to shift the line to the left side.

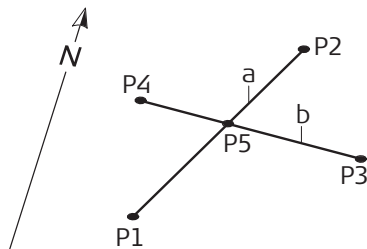

Known

- P1 First known point
- P2 Second known point
- P3 Third known point
- P4 Fourth known point
- a Line from P1 to P2
- b Line from P3 to P4

Unknown

- P5 COGO point

Access

Select the desired COGO method from the **COGO menu**.

- **DistOff**
- **Set Pt**
- **Plane**

Distance - Offset

Use the distance-offset subapplication to calculate the distance and offset of a known point, with the basepoint in relation to a line.

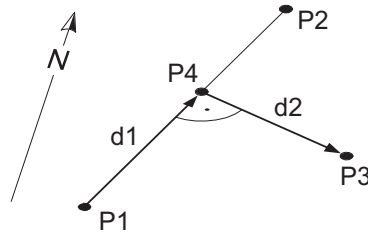

Known

- P0 Instrument station
- P1 Start point
- P2 End point
- P3 Offset point

Unknown

- d1 d Line
- d2 d Offset
- P4 COGO (base) point

Set point by....

Use the set point subapplication to calculate the coordinates of a new point in relation to a line from known longitudinal and offset distances.

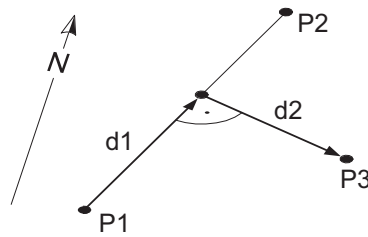

Known

- P0 Instrument station
- P1 Start point
- P2 End point
- d1 d Line
- d2 d Offset

Unknown

- P3 COGO point

Plane

Use the COGO plane application to calculate the coordinates of a new point and its height and offset, in relation to a known plane and offset point.

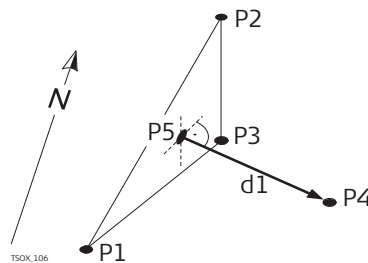

Known

- P1 Point 1 which defines plane
- P2 Point 2 which defines plane
- P3 Point 3 which defines plane
- P4 Offset point

Unknown

- P5 COGO (intersection) point
- d1 Offset

11.6.5

Line - Extension

Access

Select **Line-Ex** from the **COGO** menu.

Extension

Use the Extension subapplication to calculate the extended point from a known base line.

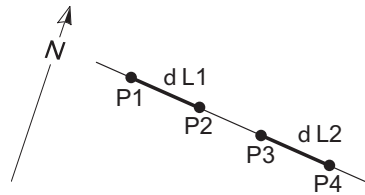

Known

P1 Baseline start point
P3 Baseline end point
dL1,dL2 Distance

Unknown

P2, Extended COGO points
P4

11.7

Area & Volume

Description

Area is an application used to compute online areas to a maximum of 50 points connected by straights. The target points have to be measured, selected from memory, or entered via the keypad in a clockwise direction. The calculated area is projected onto the horizontal plane (2D) or projected onto the sloped reference plane defined by three points (3D). Furthermore a volume with constant height can be calculated in relation to the area (2D/3D).

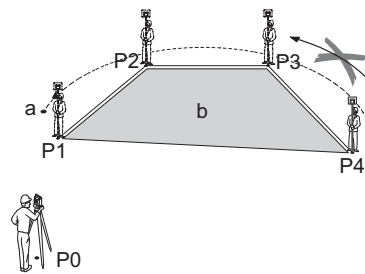

P0 Instrument station
P1 Start point
P2-4 Target points
a Perimeter, polygonal length from start point to the current measured point.
b Calculated area always closed to the start point P1, projected onto the horizontal plane.

Access

1. Select **Apps** from the **MAIN MENU**.
2. Select **Area** from the **Apps** menu.
3. Complete application pre-settings. Refer to "5 Applications - Getting Started".

AREA & VOLUME

The graphic always shows the area projected onto the horizontal plane.

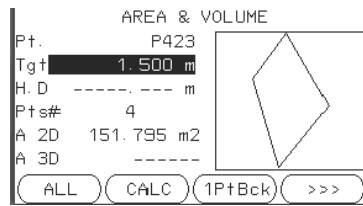

1PtBACK

To undo measurement or selection of the previous point.

CALC

To display and record additional results (perimeter, volume).

>>> **VOLUME**

To calculate a volume with constant height. The heights have to be entered or measured.

>>> **Def. 3D**

To define the sloped reference plane by selecting or measuring three points.



The 2D area is calculated and displayed once three points have been measured or selected. The 3D area is calculated once the sloped reference plane is defined by three points.

Graphical representation

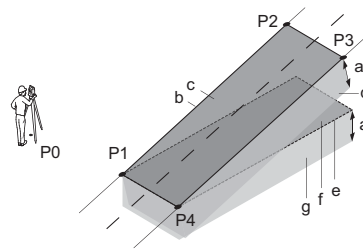

- P0 Instrument station
- P1 Target point which defines the sloped reference plane
- P2 Target point which defines the sloped reference plane
- P3 Target point which defines the sloped reference plane
- P4 Target point
- a Constant height
- b Perimeter (3D), polygonal length from the start point to the current measured point of the area (3D)
- c Area (3D), projected onto the sloped reference plane
- d Volume (3D) = $a \times c$
- e Perimeter (2D), polygonal length from the start point to the current measured point of the area (2D)
- f Area (2D), projected onto the horizontal plane
- g Volume (2D) = $f \times a$

Next step

Press **CALC** to calculate area and volume and proceed to the **Area & Volume Result** screens.

2D/3D-AREA & VOLUME RESULT

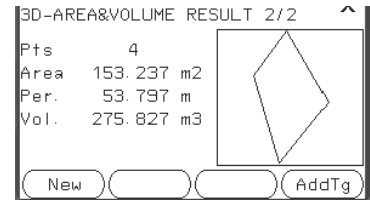
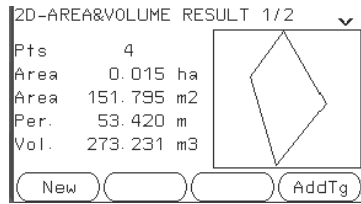

Perimeter and volume are updated if further area points are added.

Next step

- Either, press **New** to define a new area.
- Or, press **AddTg** to add a new target point to the existing area.
- Or, press **ESC** to exit the application.

11.8

Remote Elevation

Description

Remote Elevation is an application used to compute points directly above the base prism without a prism at the target point.

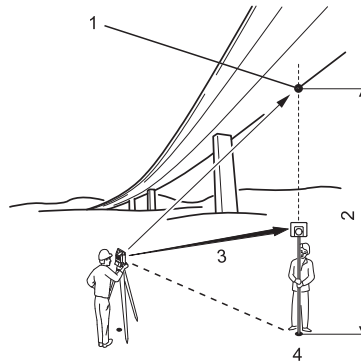

- 1 Remote point
- 2 Height difference
- 3 Slope distance
- 4 Base point

Access

1. Select **Apps** from the **MAIN MENU**.
2. Select **REM** from the **Apps** menu.
3. Complete application pre-settings. Refer to "5 Applications - Getting Started".

Remote elevation measurement

Measure to the base point or press >>> **Tgt.H=?** to determine an unknown reflector height.

Next step

After measuring, the **REMOTE ELEVATION** screen appears.

REMOTE ELEVATION - Aim at remote point

Aim the instrument at the inaccessible remote point.

Field	Description
hDIST	Height difference between the base point and the remote point.
d.d.Z	Calculated difference in Height between the base point and the remote point.

Field	Description
Z	Height of the remote point.
E	Calculated Easting coordinate for the remote point.
N	Calculated Northing coordinate the remote point.
dE	Calculated difference in Easting coordinate between the base point and the remote point.
dN	Calculated difference in Northing coordinate between the base point and the remote point.
dZ	Calculated difference in Height between the base point and the remote point.

Next step

- Either, press **OK** to save the measurement of the remote point.
- Or, press **BACK** to enter and measure a new base point.
- Or, press **ESC** to exit the application.

11.9 Reference Element - Reference Line

11.9.1 Overview

Description

Reference Element - Line is an application that facilitates the easy set out or checking of lines, for example, for buildings, sections of road, or simple excavations. It allows the user to define a reference line and then complete the following tasks with respect to that line:

- Line & offset
- Set out points

Access

1. Select **Apps** from the **MAIN MENU**.
2. Select **R_LINE** from the **Apps** menu.
3. Complete application pre-settings. Refer to "5 Applications - Getting Started".

Next step

Define the base line for the reference line.

11.9.2 Defining the Base Line

Description

A reference line can be defined by referencing a known base line. The reference line can be offset either longitudinally, in parallel or vertically to the base line, or be rotated around the first base point as required. Furthermore the reference height can be selected as the first point, second point or interpolated along the reference line.

Define the base line

The base line is fixed by two base points. All points can be either measured, manually entered, or selected from the memory.

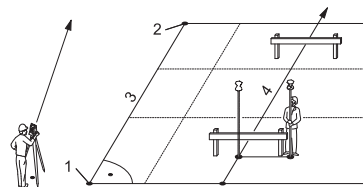

- 1 1st base point
- 2 2nd base point
- 3 Base line
- 4 Reference line

Define the base line by measuring or selecting the start and end points of the line.

Next step

After defining the base line the **REFERENCE LINE** screen will appear for defining the reference line.

11.9.3 Defining the Reference Line

Description

The base line can be offset from, either longitudinally, in parallel or vertically, or be rotated around the first base point. This new line created from the offsets is called the reference line. All measured data refers to the reference line.

Reference line

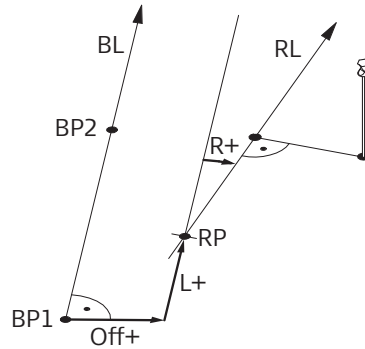

- BP Base point
- BL Base line
- RP Reference point
- RL Reference line
- Off Parallel offset
- L Longitudinal offset
- R Rotation parameter

Access

After completing the measurements required for defining the base line, the **REFERENCE LINE** screen will appear.

REFERENCE LINE

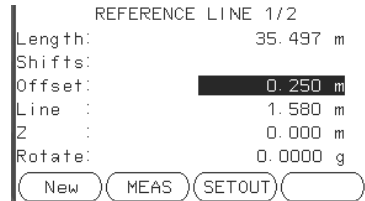

New
To define a new base line.

MEAS
To measure Line & Offset.

SETOUT
To set out points orthogonal to the reference line.

Field	Description
Length	Length of the base line.
Offset	Parallel offset of the reference line relative to the base line (P1-P2). Positive values are to the right of the base line.
Line	Longitudinal offset of the start point, reference point (P3), of the reference line in the direction of base point 2. Positive values are towards base point 2.
Z	Height offset of the reference line to the selected reference height. Positive values are higher than the selected reference height.
Rotate	Rotation of the reference line clockwise around the reference point (P3).
Ref.Hgt	Pt. 1 Height differences are computed relative to the height of the first reference point.

Field	Description
Pt. 2	Height differences are computed relative to the height of the second reference point.
Interpolated	Height differences are computed along the reference line.
w/o. Height	Height differences are not computed or shown.

Next step

Select a softkey option, **MEAS** or **SETOUT** to proceed to a subapplication.

11.9.4

Subapplication Measure Line & Offset

Description

The Measure Line & Offset subapplication calculates from measurements or coordinates, longitudinal offsets, parallel offsets and height differences of the target point relative to the reference line.

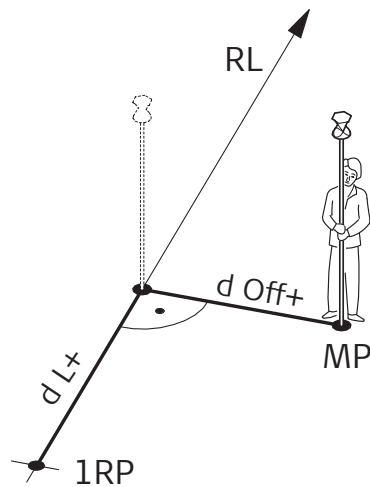

- RL Reference line
- 1RP Start point
- MP Measured point
- dL Longitudinal offset
- dOff Parallel offset

Example of height difference relative to first reference point

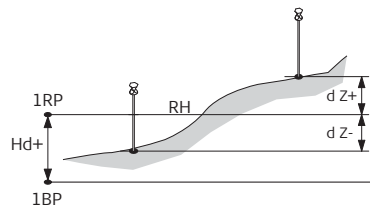

- 1RP 1st reference point
- 1BP 1st base point
- RH Reference height
- Hd Height difference between reference and base point
- d Z Height difference from reference height

Access

Press **MEAS** in the **REFERENCE LINE** screen.

Measure

Field	Description
dL	Calculated distance longitudinal to the reference line.

Field	Description
dO	Calculated distance perpendicular from the reference line.
dH	Calculated height difference relative to the defined reference height.

Next step

- Either, press **ALL** to measure and record.
- Or, press >>> **BACK** to return to the **REFERENCE LINE** screen.

11.9.5 Subapplication Setout

Description

The setout subapplication calculates the difference between a measured point and the calculated point. The orthogonal (dLine, dOffset, d.d.Z) and polar (dHA, d.hDIST, d.d.Z) differences are displayed.

Example orthogonal setout

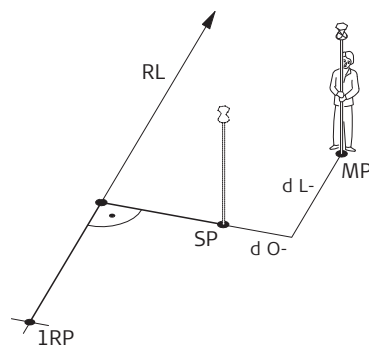

- 1RP 1st reference point
- SP Set out point
- MP Measured point
- RL Reference line
- dL Longitudinal offset
- dO Parallel offset

Access

Press **SETOUT** from the **REFERENCE LINE** screen.

SETOUT

Enter the set out elements for the target points to be set out relative to the reference line.

Field	Description
Line	Longitudinal offset: Positive if set out point is further away from the reference line.
Offset	Perpendicular offset: Positive if set out point is to the right of the reference line.
Z	Height offset: Positive if set out point is higher than the reference line.

Next step

Press **OK** to proceed to measurement mode.

SETOUT

The signs for the distance and angle differences are correction values (required minus actual). The arrows indicate the direction to move to get to the set out point.

```

SETOUT 1/2
Pt. : P414 1
Tg+HGT: 1.500 m
dH. A. : ← -0.6764 g
d. H. D. : ↓ -2.371 m
d. d. Z. : ↑ 0.082 m
[ALL] [MEAS] [REC] [>>>>]

```

>>> **NextPt**

To add the next point to be set out.

Field	Description
d HA	Horizontal direction from the measured point to the set out point. Positive if the telescope must be turned clockwise to the set out point.
d.H.D	Horizontal distance from the measured point to the set out point. Positive if the set out point is further away than the measured point.
d.d.Z	Height difference from the measured point to the set out point. Positive if the set out point is higher than the measured point.
dOffset	Perpendicular distance from the measured point to the set out point. Positive if the set out point is to the right of the measured point.
dLine	Longitudinal distance from the measured point to the set out point. Positive if the set out point is further away than the measured point.

Messages

The following are important messages or warnings that may appear.

Messages	Description
Base line too short !	Base line is shorter than 1 cm. Choose base points such that the horizontal separation of both points is at least 1 cm.
Coordinates invalid !	No coordinates or invalid coordinates for a point. Ensure that points used have at least Easting and Northing coordinates.

Next step

- Either, press **ALL** to measure and record.
- Or, press >>> **BACK** to return to the **REFERENCE LINE** screen.
- Or, continue selecting **ESC** to exit the application.

11.9.6

Grid Setout

Description

The Grid subprogram calculates and displays the stake out elements for the points on the grid, orthogonal (**dL**, **dO**, **dH**) and polar (**dH.A.**, **d.H.D.**, **d.d.z.**). The grid is defined without boundaries. It can be extended over the first and second base points of the reference line.

Example Grid Setout

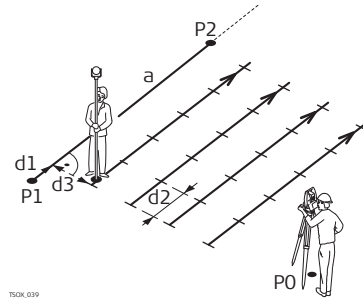

- a Reference line
- P0 Instrument station
- P1 Start point
- P2 End point
- d1 Start distance
- d2 Increment
- d3 Line offset

Access

Press **Grid** from the **REFERENCE LINE** screen.

Grid definition

Enter the chainage and the increment of grid points in length and cross direction of the reference line.

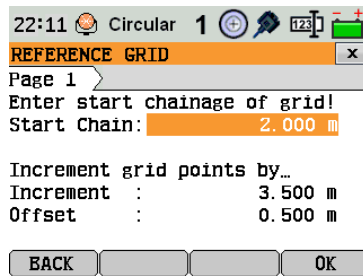

Field	Description
Start Chain	Distance from the reference line start point to the beginning grid start point.
Increment	Length of incrementation.
Offset	Offset distance from the reference line.

Next step

Press **OK** to proceed to the **REFERENCE GRID - SETOUT** screen.

REFERENCE GRID - SET-OUT

The signs for the distance and angle differences are correction values (required minus actual). The arrows indicate the direction to move to get to the setout point.

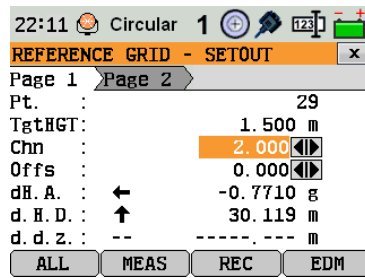

Field	Description
Chn	The chainage of the grid setout point.
Offs	Offset increment values. The setout point is to the right of the reference line.
dH.A.	Horizontal direction from the measured point to setout point. Positive if the telescope must be turned clockwise to the setout point.
d.H.D.	Horizontal distance from the measured point to setout point. Positive if the setout point is further away than the measured point.
d.d.z.	Height difference from the measured point to the setout point. Positive if the setout point is higher than the measured point.
Line	Grid increment values. The setout point is in the direction from the first to the second reference point.
dL	Longitudinal distance from the measured point to the setout point. Positive if setout point is further away than the measured point.
dO	Perpendicular distance from the measured point to the setout point. Positive if setout point is to the right of the measured point.

Next step

- Either, press **ALL** to measure and record.
- Or, press **ESC** to return to the **Enter start chainage of grid!** screen and from there, press **BACK** to return to the **REFERENCE LINE** screen.

11.9.7

Line Segment

Description

The line segment application calculates and displays the setout elements for the points along the line, orthogonal (**dL**, **dO**, **dH**) and polar (**dH.A.**, **dH.D.**, **d.d.z.**). Line Segment is limited to the reference line, between the defined start and end points of the line.

Example Line Segment Setout

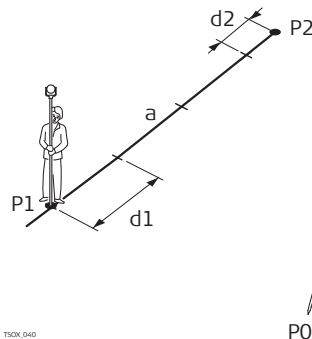

- P0 Instrument station
- P1 First reference point
- P2 Second reference point
- a Reference line
- d1 Segment length
- d2 Misclosure

Access

Press **>>>** **Segment** from the **REFERENCE LINE** screen.

Segment Definition

Enter either the number of segments, or the length of segments and define how the remaining line length is treated. This misclosure can be placed at the start, at the end, at the start and the end or distributed evenly along the line.

22:11 Circular 1

LINE SEGMENT

Page 1

Define Line Segment

Line Length : 51.176 m

Segment Length: 3.412 m

Segment No. : 15

Misclosure : 3.408 m

Distrib. : None

BACK OK

Field	Description
Line Length	Calculated length of the defined reference line.
Segment Length	Length of each segment. Updated automatically if the number of segments is entered.
Segment No.	Number of segments. Updated automatically if the segment length is entered.
Misclosure	Any remaining line length after segment length has been entered.
Distrib.	Method of misclosure distribution.
	<p>None All of the misclosure will be placed after the last segment.</p> <p>Equal The misclosure will be equally distributed between all segments.</p> <p>At start All of the misclosure will be placed before the first segment.</p> <p>StartEnd The misclosure is equally distributed at the start and at the end of the segment line.</p>

Next step

Press **OK** to proceed to the **LINE SEGMENT - SETOUT** screen.

LINE SEGMENT - SETOUT

The signs for the distance and angle differences are correction values (required minus actual). The arrows indicate the direction to move to get to the setout point.

22:11 Circular 1

LINE SEGMENT - SETOUT

Page 1 Page 2

Pt. : 29

TgtHGT: 1.500 m

Segm : 1

CumL : 3.412 m

dH. A. : → +2.1856 g

d. H. D. : ↑ 30.283 m

d. d. z. : --- m

ALL MEAS REC EDM

Field	Description
Segm	Segment number. Includes the misclosure segment, if applicable.
CumL	Cumulation of the segment lengths. Changes with the current number of segments. Includes the misclosure segment length if applicable.
dH.A.	Horizontal direction from the measured point to the setout point. Positive if the telescope must be turned clockwise to the setout point.
d.H.D.	Horizontal distance from the measured point to the setout point. Positive if the setout point is further away than the measured point.
d.d.z.	Height difference from the measured point to the setout point. Positive if the setout point is higher than the measured point.
dL	Longitudinal distance from the measured point to the setout point. Positive if setout point is further away than the measured point.
dO	Perpendicular distance from the measured point to the setout point. Positive if setout point is to the right of the measured point.

Messages

The following are important messages or warnings that may appear.

Messages	Description
Baseline too short!	Base line is shorter than 1 cm. Choose base points such that the horizontal separation of both points is at least 1 cm.
Coordinates invalid!	No coordinates or invalid coordinates for a point. Ensure that points used have at least Easting and Northing coordinates.
Recording to interface!	Data Output is set to Interface in the GENERAL SETTINGS menu. To be able to successfully start reference line, Data Output must be set to Int. Memory .

Next step

- Either, press **ALL** to measure and record.
- Or, press **ESC** to return to the **Define Line Segment** screen and from there, press **BACK** to return to **REFERENCE LINE** screen.
- Or, continue selecting **ESC** to exit the application.

11.10

Reference Element - Reference Arc

11.10.1

Overview

Description

The Reference Element - Arc application allows the user to define a reference arc and then complete the following tasks with respect to the arc:

- Line & offset
- Set out (Point, Arc, Chord, Angle)

Access

1. Select **Apps** from the **MAIN MENU**.
2. Select **R_ARC** from the **Apps** menu.
3. Complete application pre-settings. Refer to "5 Applications - Getting Started".

Next step

Define the reference arc.

11.10.2

Defining the Reference Arc

Description

The reference arc can be defined by a center point and start point, or a start point, end point, and radius. All points can be either measured, manually entered, or selected from the memory.

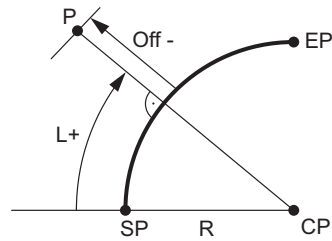

- SP Start point
- EP End point
- CP Center point
- R Radius of arc
- L Distance from start of arc, following curve
- Off Perpendicular distance from arc



All arcs are defined in a clockwise direction and all calculations are made in two dimensions.

Access

Select **Arc** and then the method to define the arc by:

- **Start-/ Centre Pt**
- **Start-/ End Pt/ Rad.**
- **3 Points**

Reference Arc - Measure to start point

Field	Description
Start Pt	Point ID of the start point.
C-Pt	Point ID of the center point.
End Pt	Point ID of the end point.
Radius	Radius of the arc.

Next step

After defining the reference arc the **REFERENCE ARC** screen will appear.

REFERENCE ARC

```

REFERENCE ARC
StartPt:          P410
EndPt  :          P411
CtrPt  :          -----
Radius :          32.000 m
    
```

- New** To define a new base arc.
- MEAS** To measure Line & Offset.
- SET OUT** To set out.

Next step

Select a softkey option, **MEAS** or **SET OUT**, to proceed a subapplication.

11.10.3

Subapplication Measure Line & Offset

Description

The Measure Line & Offset subapplication calculates from measurements or coordinates, longitudinal and orthogonal offsets and height differences of the target point relative to the reference arc.

Access

Press **MEAS** from the **REFERENCE ARC** screen.

Measure

Field	Description
dLine	Calculated distance longitudinal to the reference arc.
dOffset	Calculated distance perpendicular from the reference arc.
d.d.Z	Calculated height difference relative to the start point of reference arc.

Next step

- Either, press **ALL** to measure and record.
- Or, press >>> **BACK** to return to the **REFERENCE ARC** screen.

11.10.4

Subapplication Setout

Description

The setout subapplication calculates the difference between a measured point and the calculated point. The reference arc application supports four ways to set out:

- Set out point
- Set out chord
- Set out arc
- Set out angle

Set out point

To set out a point by entering a line and an offset value.

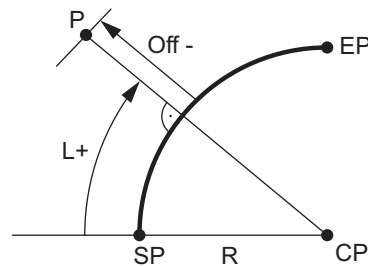

- CP Center point of arc
- SP Start point of arc
- EP End point of arc
- P Set out point
- R Radius of arc
- L Line offset
- Off Perpendicular offset

Set out arc

To set out a series of equidistant points along the arc.

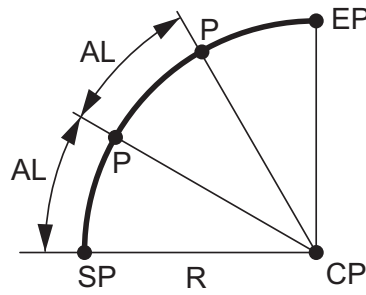

- CP Center point of arc
- SP Start point of arc
- EP End point of arc
- P Set out point(s)
- R Radius of arc
- AL Arc length

Set out chord

To set out a series of equidistant chords along the arc.

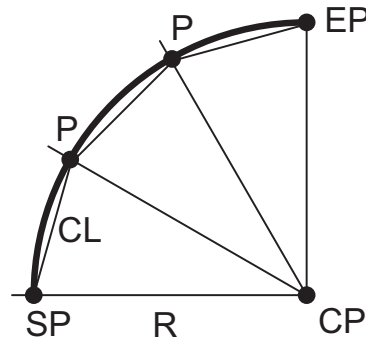

- CP Center point of arc
- SP Start point of arc
- EP End point of arc
- P Set out point(s)
- R Radius of arc
- CL Chord length

Set out angle

To set out a series of points along the arc defined by the angle segments from the center point of the arc.

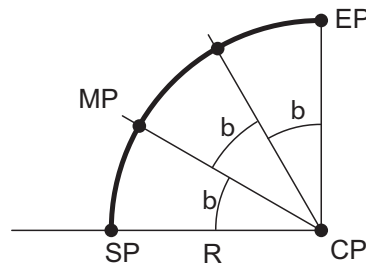

- CP Center point of arc
- SP Start point of arc
- EP End point of arc
- MP Measured point
- R Radius of arc
- b Central angle

Access

1. Press **SETOUT** from the **REFERENCE ARC** screen.
2. Select one of the four methods of set out available.

Set out point, arc, chord or angle

Enter the set out values. Press **PrevPt/NextPt** to toggle through the calculated set out points.

Field	Description
Distrib.	For set out arc: Method of misclosure distribution. If the entered arc length is not an integer of the whole arc, there will be a misclosure.

Field	Description
None	All of the misclosure will be added to the last arc-section.
Equal	The misclosure will be equally distributed between all sections.
Start Arc	All of the misclosure will be added to the first arc-section.
Start/End	The misclosure will be added half to the first arc-section and half to the last arc-section.
Arc Length	For set out arc: The length of the arc-segment to set out.
Chord Length	For set out chord: The length of the chord to set out.
Angle	For set out angle: The angle around the center point of the arc, of the points to be set out.
Line	For set out arc, chord and angle: Longitudinal offset from the reference arc. This is calculated by the arc length, chord length or angle and the selected misclosure distribution. For set out point: Longitudinal offset from the reference arc.
Offset	Perpendicular offset from the reference arc.

Next step

Press **OK** to proceed to measurement mode.

REFERENCE ARC - SET OUT

The signs for the distance and angle differences are correction values (required minus actual). The arrows indicate the direction to move to get to the set out point.

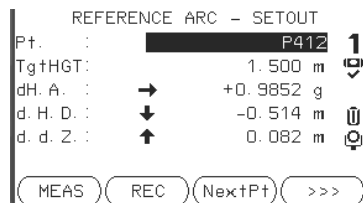

NextPt To add the next point to be set out.

Field	Description
d HA	Horizontal direction from the measured point to the set out point. Positive if the telescope must be turned clockwise to the set out point.
d.H.D	Horizontal distance from the measured point to the set out point. Positive if the set out point is further away than the measured point.
d.d.Z	Height difference from the measured point to the set out point. Positive if the set out point is higher than the measured point.

Next step

- Either, press >>> **ALL** to measure and record.
- Or, press >>> **BACK** to return to the **REFERENCE ARC** screen.
- Or, continue selecting **ESC** to exit the application.

11.11 Construction

11.11.1 Starting Construction

Description Construction is an application used to define a construction site by combining set-up of the instrument along a construction line, measuring and setting out points in relation to the line.

Access

1. Select **Apps** from the **MAIN MENU**.
2. Select **CONSTR.** from the **Apps** menu.
3. Select **Set EDM:** to set the EDM settings. Refer to "5.2 EDM Settings".
4. Select:
 - **New line** - To define a new construction site, or
 - **Continue line** - To continue with a previous construction site (skips set-up).



If coordinates were entered by **COORD** and measured to known points, a plausibility check displays the calculated line length, the actual length and the difference.

Next step

Measure to the line start and end points and the **LAY-OUT** screen appears.

11.11.2 Layout

Description

Search or enter points for setting out relative to the defined construction line. The on-screen graphics show the position of the prism relative to the set out point. Below the graphic, the exact values are displayed, combined with arrows to show the direction for setting out the point.



- Be aware that the line start point and the line end point are measured in the previous coordinate system. When setting out these points they appear in the old system and appear as shifted.
- During use of the application the previous orientation and station parameters will be replaced by the new calculated ones. The line start point will be set to E=0, N=0.
- The height of the line start point is always used as the reference height!

Access

- Either, select **New line** from the Construction pre-settings screen and measure start and end points of the line.
- Or, select **Continue with line** from the Construction pre-settings screen.

LAY-OUT

The graphics are scaled to give a better overview. Therefore it is possible that the set out point moves in the graphic.

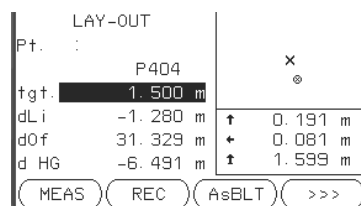

AsBLT To switch to AsBuilt mode to check points relative to the construction line.

>>> Shift To enter values for shifting the line.

Field	Description
dLi	Longitudinal offset: Positive if target point is further away than the measured point.
dOf	Perpendicular offset: Positive if target point is to the right of the measured point.

Field	Description
d HG	Height offset: Positive if target point is higher than the measured point.

Next step

- Either, press **AsBLT** to check point locations relative to a construction line.
- Or, press >>> **Shift** to enter offset values for shifting the construction line.

11.11.3

As Built Check

Description

The As built screen displays the Line, Offset and d.d.Z of a measured point in relation to the construction line. The on-screen graphics show the position of the measured point relative to the construction line.



The height of the line start point is always used as the reference height!

Access

Press **AsBLT** from the **LAY OUT** screen.

AS-BUILT CHECK

The graphics are scaled to give a better overview. Therefore it is possible that the station point moves in the graphics.

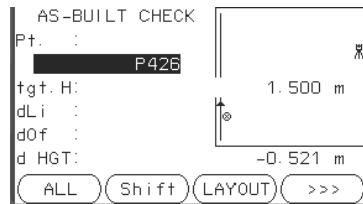

LAYOUT

To switch to Layout mode to set out points.

Shift

To enter values for shifting the line.

Field	Description
dLi	Longitudinal offset: Positive if measured point is further along the construction line from the start point.
dOf	Perpendicular offset: Positive if measured point is to the right of the construction line.
dHGT	Calculated difference in height: Positive if measured point is higher than the construction line start point height.

11.12

Road 2D

Description

Road Alignment is an application used to measure or set out points relative to a defined element. The element can be a line, curve or spiral. Chainage, incremental set outs and offsets (left and right) are supported.

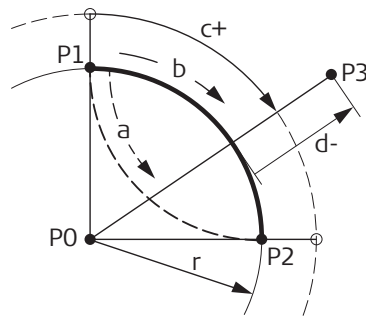

- P0 Center point
- P1 Start point of arc
- P2 End point of arc
- P3 Point to set out
- a Anti-clockwise
- b Clockwise
- c+ Distance from start of arc, following curve
- d- Perpendicular offset from arc
- r Radius of arc

Access

1. Select **Apps** from the **MAIN MENU**.
2. Select **Road 2D** from the **Apps** menu.
3. Complete application pre-settings.
4. Select the element type:
 - **Line**
 - **Curve**
 - **Spiral**

Elements

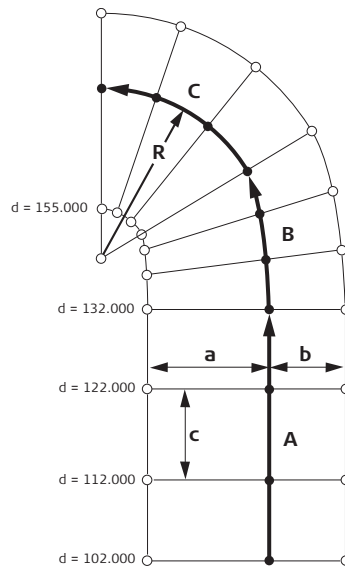

- A Straight
- B Spiral
- C Curve
- R Radius
- a Perpendicular offset left
- b Perpendicular offset right
- c Increment
- d Stationing

Define the element step-by-step

1. Enter, measure or select from memory the start and end points.
2. For curve and spiral elements the **ROAD** screen for defining the element appears.

```

ROAD ALIGNMENT
Select Method and enter data !
Method : Rad/Par
Radius : 400.000 m
Parameter: 600.000 m
Length : 900.000 m
Direction: Clk-wise
Type : Spir. In
  
```

BACK [] [] OK

3. For a curve element:
- Enter the radius and curve direction.
 - Press **OK**.
- For a spiral element:
- Select the method to be used, **Rad/Par** or **Rad/Len**.
 - Enter the radius and parameter, or radius and length, depending on the method chosen.
 - Select the type and direction of the spiral.
 - Press **OK**.

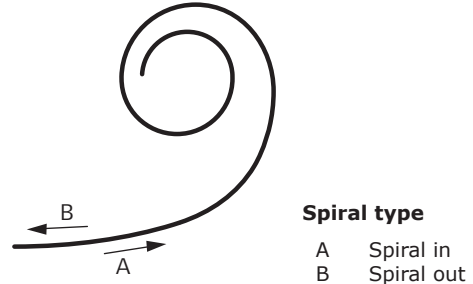

4. When the element has been defined the **ROAD-MAIN** appears.

Station and method

Enter the station values and press:

- **SET OUT**: to select the point and offset (center, left or right), to set out and start the measurement. The correction from actual point to set out point is shown on the display.
- **MEASURE**: to measure, or select points from memory, to calculate the chainage, line and offset from the defined element.

Enter set out values

Enter set out values!

Station : 1100.000 m
 Offs.Left : 5.000 m
 Offs.Right : 4.000 m
 Increment : 10.000 m
 Z : 0.000 m

BACK RESET OK

Next step

- If in set out mode, press **OK** to begin setting out.
- Or, if in measurement mode, press **ALL** to measure and record.

11.13

Road 3D

11.13.1

Starting

Description

Road 3D is an application used to stake out points or for as-built checks relative to a road alignment, including slopes. It supports the following features:

- Horizontal alignments with the elements straight, curve, and spiral (entry and exit as well as partial).
- Vertical alignments with the elements straight, curve and quadratic parabola.
- Creation, view and deletion of alignments onboard.
- Use of design height of vertical alignments or manually entered heights.
- Log file via Format manager of GGO.

Road 3D methods

Road 3D has the following applications:

- Subprogram Check
- Subprogram Setout
- Subprogram Check Slope
- Subprogram Slope Setout

Road 3D step-by-step

1. Create or upload road alignments.
2. Select horizontal and/or vertical alignment files.
3. Define setout/check/slope parameter.
4. Select one of the Road 3D applications.



- The alignments must be continuous because geometrical gaps and chainage equations are not supported.
- The file name for the horizontal alignment file must have the prefix ALN, for example, ALN_HZ_Axis_01.gsi. The file name for the vertical alignment files must have the prefix PRF, for example PRF_VT_Axis_01.gsi. File names can be 16 characters long.
- The uploaded or created road alignments are permanent and stored even if the program is closed.
- Road alignments can be deleted onboard or via GGO Data Exchange Manager.

11.13.2

Basic Terms

Elements of a road project

Road projects consist, in general, of a horizontal and a vertical alignment.

Any project point P1 has E, N and Z coordinates in a determined coordinate system and has three positions.

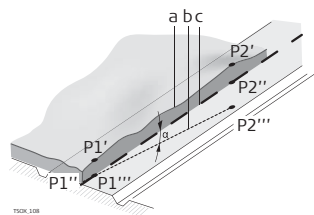

- P1' Position on natural surface
- P1'' Position on vertical alignment
- P1''' Position on horizontal alignment

With a second point P2 the alignment is defined.

- P1' P2' Projection of the alignment onto the natural surface.
- P1'' P2'' Vertical alignment
- P1''' P2''' Horizontal alignment
- α Grade angle between the vertical and horizontal alignment.
- a Natural surface
- b Horizontal alignment
- c Vertical alignment

Horizontal geometry elements

For onboard input Road 3D supports the following elements for horizontal alignments.

Element	Description
---------	-------------

Straight A straight has to be defined by:

- Start point (P1) and end point (P2) with known Easting and Northing coordinates.

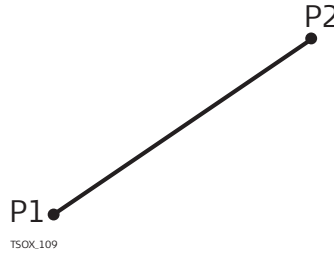

P1 Start point
P2 End point

Curve A circular curve has to be defined by:

- Start point (P1) and end point (P2) with known Easting and Northing coordinates.
- Radius (R).
- Direction: Clockwise (b) or Anticlockwise (a).

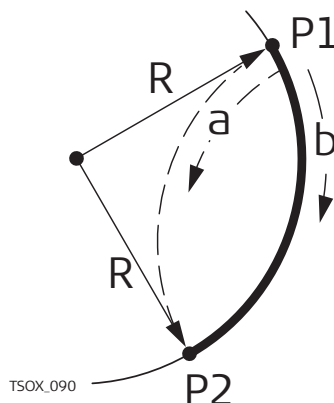

P1 Start point
P2 End point
R Radius
a Anticlockwise direction
b Clockwise direction

Spiral / Clothoid A spiral is a transition curve whose radius changes along its length. A spiral has to be defined by:

- Start point (P1) and end point (P2) with known Easting and Northing coordinates.
- Radius at the start of the spiral (R).
- Spiral parameter ($A = \sqrt{L \cdot R}$) or length (L) of the spiral.
- Direction: Clockwise or Anticlockwise.
- Spiral type: Spiral in or Spiral out.

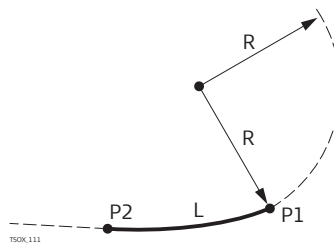

P1 Start point
P2 End point
R Radius
L Length

Spiral types

- Entry spiral (Spiral in = A): Spiral with a radius of infinity at the start and a given radius at the end.
- Exit spiral (Spiral out = B): Spiral with a given radius at the start and radius of infinity at the end.
- Partial/Ovoid spiral: A spiral with a given radius at the start and another given radius at the end.

Element	Description
A	Entry spiral
B	Exit spiral

Vertical geometry elements

For onboard input Road 3D supports the following elements for vertical alignments.

Element	Description
Straight	<p>A straight has to be defined by:</p> <ul style="list-style-type: none"> Start chainage and start height of P1. End chainage and end height of P2, or length (L) and slope (%).
	<p>P1 Start point P2 End point L Length % Slope</p>

Transition curve	<p>A circular curve has to be defined by:</p> <ul style="list-style-type: none"> Start chainage and start height of P1. End chainage and end height of P2. Radius (R). Type: Convex (crest) or Concave (sag).
	<p>a Convex b Concave</p> <p>P1 Start point P2 End point R Radius</p>

Quadratic parabola	<p>A quadratic parabola has the advantage that the rate of change of grade is constant, resulting in a "smoother" curve. A quadratic parabola has to be defined by:</p> <ul style="list-style-type: none"> Start chainage and start height of P1. End chainage and end height of P2. Parameter, or Length (L), grade of entry straight (GradeIn) and grade of exit straight (GradeOut).
	<p>P1 Start point P2 End point L Length % Grade</p>

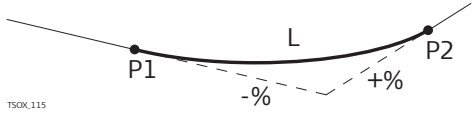
Element	Description
	P1 Start point P2 End point L Length % Slope

Horizontal and vertical geometry elements combined

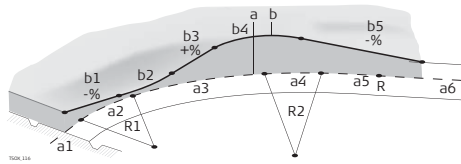

a = Horizontal alignment (top view)

- R1 Radius 1
- R2 Radius 2
- a1 Straight
- a2 Curve with R1
- a3 Partial spiral with R1 and R2
- a4 Curve with R2
- a5 Spiral out with R2 and $R=\infty$
- a6 Straight

b = Vertical alignment (front view)

- b1 Straight
- b2 Curve
- b3 Straight
- b4 Parabola
- b5 Straight

- Tangent point



Start and end chainage and tangent points can be different for the horizontal and vertical alignments.

Slope elements

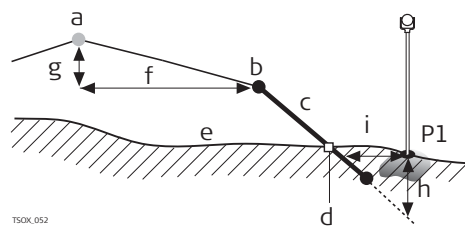

- P1 Measured point
- a Horizontal alignment
- b Hinge point
- c Slope
- d Catch point
- e Natural surface
- f Defined offset
- g Defined height difference
- h Cut situation for defined slope
- i Δ Offset to catch point

Explanation of the slope elements:

- a **Horizontal alignment** at a defined chainage.
- b **Hinge point**, is defined by entered offset left/right and height difference.
- c **Slope** = ratio.
- d **Catch point**, or daylight point, indicates the point of intersection between the slope and the natural surface. Both the hinge point and the catch point lie on the slope.
- e **Natural surface**, is the undisturbed surface before project construction.

Cut / Fill	Description
------------	-------------

Cut situation

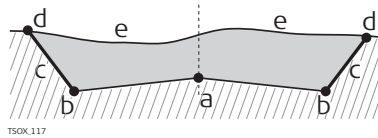

- a Horizontal alignment
- b Hinge point
- c Slope
- d Catch point
- e Natural surface

Fill situation

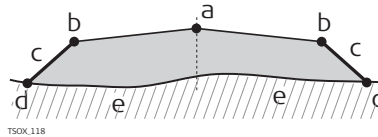

- a Horizontal alignment
- b Hinge point
- c Slope
- d Catch point
- e Natural surface



11.13.3

Creating or Uploading Alignment Files

Access

1. Select **Apps** from the **MAIN MENU**.
2. Select **ROAD 3D** from the **Apps** menu.
3. Complete program pre-settings.

Select Alignment File:

Field	Description
Horiz. Aln.	List of available horizontal alignment files.  Using a horizontal alignment file is mandatory.
Verti. Aln.	List of available vertical alignment files.  Using a vertical alignment file is not mandatory. A height can be defined manually instead.

Next step

- Either, press **NEW** to name and define a new alignment file.
- Or, press **OK** to select an existing alignment file and proceed to the **Define Setout/Check/Slope** values screen.

Define Setout/Check/Slope

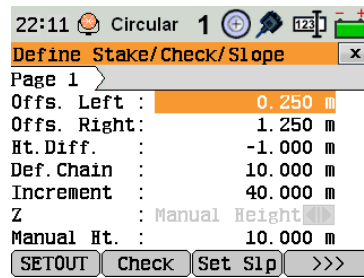

SETOUT

To start the application **SETOUT**.

Check

To start the application **Check**.

Set Slp

To start the application **Slope Setout**.

>>> **Ch Slp**

To start the application **Check Slope**.

Field	Description
Offs. Left	Horizontal offset to the left of the horizontal alignment.
Offs. Right	Horizontal offset to the right of the horizontal alignment.
Ht. Diff.	Vertical offset, either up or down, from the horizontal alignment.
Def. Chain	Defined chainage for stake out.
Increment	Value by which the defined chainage can be incremented or decremented in applications Stake and Stake Slope.
Z	<p>Manual Height Height reference for height calculations. If enabled this height is used for all applications.</p> <p>Design Height The height reference for height calculations is the selected vertical alignment file.</p>
Manual Ht.	Height to be used for Manual Height .

Next step

Select a softkey option, **SETOUT**, **Check**, **Set Slp** or >>> **Ch Slp**, to proceed to an application.

11.13.4

Setout

Description

The application Setout is used to stake out points relative to an existing alignment. The height difference is relative to a vertical alignment or manually entered height.

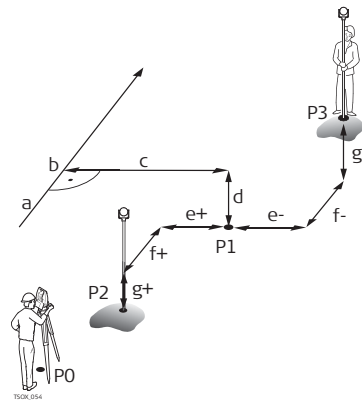

- P0 Instrument station
- P1 Target point
- P2 Measured point
- P3 Measured point
- a Horizontal alignment
- b Defined chainage
- c Offset
- d Height difference
- e+ Δ Offset, positive
- e- Δ Offset, negative
- f+ Δ Chainage, positive
- f- Δ Chainage, negative
- g+ Δ Height, positive
- g- Δ Height, negative

Access

Press **SETOUT** from the **Define Setout/Check/Slope** values screen.

SETOUT

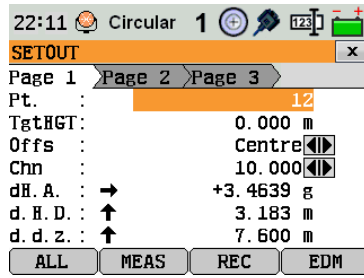

☞ To find/enter codes, press the **FNC**/Favourites key and select **Coding**.

Field	Description
Chn	Selected chainage to stake out.
dH.A.	Angle offset: Positive if the stake out point is to the right of the measured point.
d.H.D.	Horizontal offset: Positive if the stake out point is further away than the measured point.
d.d.z.	Height offset: Positive if the stake out point is higher than the measured point.
dCh	Longitudinal offset: Positive if the stake out point is further away than the measured point.
dOf	Perpendicular offset: Positive if the stake out point is to the right of the measured point.
Def.East	Calculated East coordinate of the stake out point.
Def.North	Calculated North coordinate of the stake out point.
Def.Hght	Calculated Height of the stake out point.

Next step

- Either, press **ALL** to measure and record.
- Or, press **ESC** to return to the **Define Setout/Check/Slope** values screen.

11.13.5

Check

Description

The application Check is used for as-built checks. The points can be measured or selected from the memory. The chainage and offset values are relative to an existing horizontal alignment, and the height difference is relative to a vertical alignment or manually entered height.

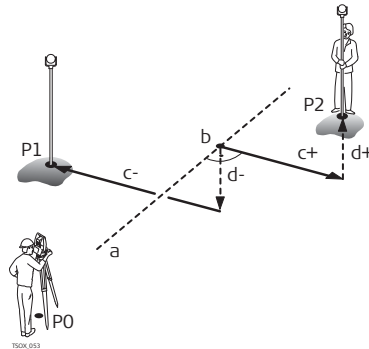

- P0 Instrument station
- P1 Target point
- P2 Target point
- a Horizontal alignment
- b Chainage
- c+ Offset, positive
- c- Offset, negative
- d+ Height difference, positive
- d- Height difference, negative



Defined chainage and increment values will not be considered in the application Check.

Access

Press **Check** from the **Define Setout/Check/Slope** values screen.

3D-Road Check

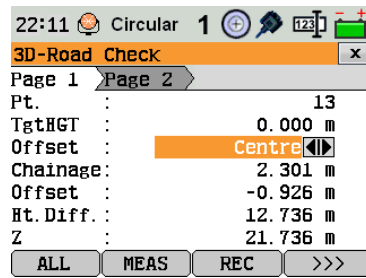

Field	Description
Offset	Defined horizontal offset. Left, Right or Centre .
Chainage	Current chainage from measured point.
Offset	Perpendicular offset to alignment.
Ht. Diff.	Height difference between the measured point and the defined height.
dE	Calculated difference in Easting coordinate between the measured point and the alignment element.
dN	Calculated difference in Northing coordinate between the measured point and the alignment element.

Next step

- Either, press **ALL** to measure and record.
- Or, press **ESC** to return to the **Define Setout/Check/Slope** values screen.

11.13.6

Slope Setout

Description

The application Slope Setout is used to stake out the catch point, which is the intersection point of a defined slope with the natural surface.

The slope is always defined as starting from a hinge point. If the parameter offset right/left and height difference are not entered, the point at the defined chainage on the horizontal alignment is the hinge point.

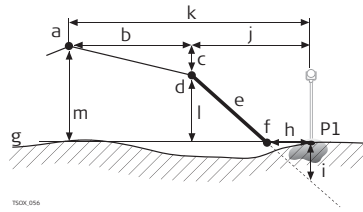

- P1 Measured point
- a Horizontal alignment
- b Defined offset
- c Defined height difference
- d Hinge point
- e Defined slope
- f Catch point
- g Natural surface
- h Δ Offset to catch point
- i Cut/fill to catch point
- j Offset to hinge point
- k Offset to alignment
- l Height difference to hinge point
- m Height difference to alignment

Access

Press **Set Slp** from the **Define Setout/Check/Slope** values screen.

Define slope setout

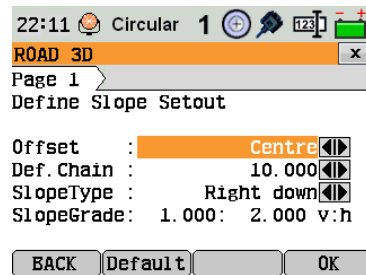

Field	Description
Offset	Horizontal offset from the horizontal alignment to define the hinge point.
Def.Chain	Defined chainage for stakeout.
SlopeType	Type of slope. Refer to "Slope type".
SlopeGrade	Slope ratio. Refer to " Slope Grade".

Slope type

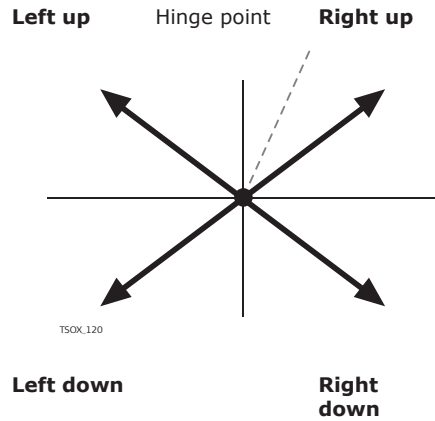

Left up

Creates an upward plane extending to the left of the defined hinge point.

Right up

Creates an upward plane extending to the right of the defined hinge point.

Left down

Creates a downward plane extending to the left of the defined hinge point.

Right down

Creates a downward plane extending to the right of the defined hinge point.

Slope Grade

Ratio of the slope. The unit for slope grade is defined in the **GENERAL SETTINGS** screen. Refer to "5.1 General Settings".

Next step

Press **Slope Setout** to proceed to the **Slope Setout** screen.

Slope setout

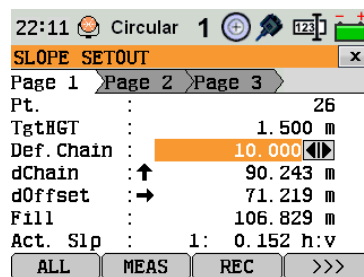

Field	Description
DefChain	Defined chainage for stake out.
dChain	Difference between the defined chainage and the measured chainage.
dOffset	Horizontal offset between the catch point of defined slope and the measured position.
Cut	Vertical offset between the catch point of the defined slope and the measured position. A cut is above the slope, a fill is below the slope.
Act.Slp	Measured slope of the reflector position to the hinge point.
Offs.Hng	Measured offset to the horizontal alignment including offset right and offset left.
dH Hinge	Height difference to the hinge point. The vertical offset between the defined height at the current chainage, and the measured position, including the defined height difference.
sDISTHng	Slope distance from the measured point to the hinge point.
Z	Height value of the measured point.

Field	Description
Act. Ch.	The measured chainage.
Offs.Aln	Measured offset to the horizontal alignment excluding offset right and offset left.
dAln	Height difference to the alignment. The vertical offset between defined height at the current chainage, and the measured position, excluding the defined height difference.
sDIST Aln	Slope distance from the measured point to the alignment.

Sign convention

Cut situation

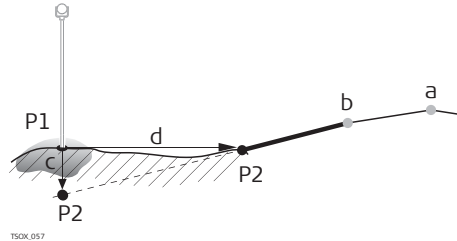

- P1 Measured point
- P2 Catch point
- a Horizontal alignment
- b Hinge point
- c Cut
- d Δ Offset to catch point

Fill situation

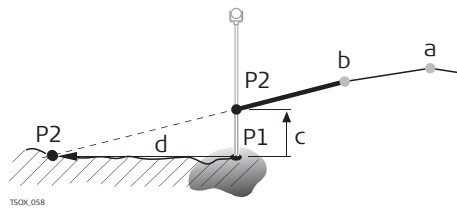

- P1 Measured point
- P2 Catch point
- a Horizontal alignment
- b Hinge point
- c Fill
- d Δ Offset to catch point

Next step

- Either, press **ALL** to measure and record.
- Or, press **ESC** to return to the **Define Setout/Check/Slope** values screen.

11.13.7

Check Slope

Description

The application Check Slope is used for as-built checks and to get information about slopes, for example on a natural surface. If the parameter offset left/right and height difference are not entered, the point on the horizontal alignment is the hinge point.

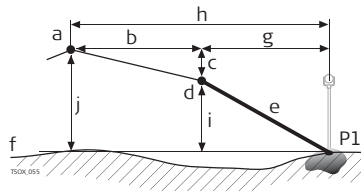

- P1 Measured point
- a Horizontal alignment
- b Defined offset
- c Defined height difference
- d Hinge point
- e Actual slope
- f Natural surface
- g Offset to hinge point
- h Offset to alignment

- i Height difference to hinge point
- j Height difference to alignment



Defined chainage and increment values will not be considered in the application Check.

Access

Press **>>>** **Ch Slp** from the **Define Setout/Check/Slope** values screen.

SLOPE CHECK HINGE

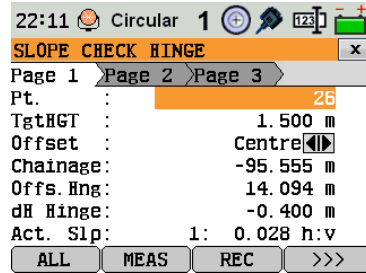

Field	Description
Offset	Defined horizontal offset. Left, Right or Center.
Chainage	Current chainage from measured point.
Offs.Hng	Offset to hinge. Measured offset to the horizontal alignment including offset right and offset left.
dH Hinge	Height difference to the hinge point. The vertical offset between the defined height at the current chainage, and the measured position including defined height difference.
Act. Slp	The measured slope ratio of the measured point to the hinge point.
sDIST Hng	Slope distance from the measured point to the hinge point.
Z	Height value of the measured point.
Offs.Aln	Measured offset to the horizontal alignment excluding offset right and offset left.
dH Aln	Height difference to the alignment. The vertical offset between defined height at the current chainage, and the measured position, excluding the defined height difference.
sDIST Aln	Slope distance from the measured point to the alignment.

Next step

- Either, press **ALL** to measure and record.
- Or, press **ESC** to return to the **Define Setout/Check/Slope** values screen.
- Or, continue selecting **ESC** to exit the application.

11.14

Traverse

11.14.1

Overview

Description

Traverse is a program used to establish control networks whereby other survey operations such as topographic surveys or point stake outs can be completed.

The Traverse methods include 2D Helmert transformation, compass rule and transit rule.

2D Helmert transformation

A Helmert transformation is calculated based on two control points. These must be the start point and the end, or closing, station. Shift, rotation and scale factor will be computed and applied to the traverse.

Starting a traverse without an initial backsight measurement will automatically result in a Helmert transformation.

Compass rule

The coordinate misclosure will be distributed with respect to the length of the traverse legs. The compass rule assumes that the biggest error comes from the longest traverse observations. This method is suitable when the precision of the angles and distances are approximately equal.

Transit rule

The coordinate misclosure will be distributed with respect to the coordinate changes in Easting and Northing. Use this method if the angles were measured with a higher precision than the distances.

Traverse step-by-step

Step	Description
1.	Start and configure Traverse.
2.	Enter station data.
3.	Select starting method.
4.	Measure a backsight point or go directly to step 5..
5.	Measure a foresight point.
6.	Repeat for the number of sets.
7.	Move to the next station.

Traverse options

- It is also possible to observe sideshots and check points during the traverse, however, check points are not included in the traverse adjustment.
- At the end of the traverse, results are displayed and an adjustment may be calculated if desired.

11.14.2

Starting and Configuring Traverse

Access

1. Select **Apps** from the **MAIN MENU**.
2. Select **Traverse** from the **Apps** menu.
3. Complete program pre-settings:

F1 Set Job:

Only one traverse per job is allowed. If an adjusted or finished traverse is already part of the selected job, then select another job. Refer to "5 Applications - Getting Started".

F2 Set Tolerances:

1. **Use Tolerances: Yes** to activate the use of tolerances.
 2. Enter limits for horizontal direction (the difference between measured and calculated azimuth to the closing point), distance (the distance between known and measured closing point), and for differences in Easting, Northing and Height. If the adjustment results, or the deviation for a check point, exceed these limits a warning message appears.
 3. Press **Cont** to save the limits and return to the **Pre-settings** screen.
4. Select **F4 Start** to begin the program.



It is not recommended to start a traverse if the memory is almost full. Doing so, may mean the traverse measurements and results cannot be saved. Accordingly, a message is displayed if less than 10% of the memory is free.

Traverse configuration

Field	Description
Traverse ID	Name of the new traverse.
Desc.	Description, if desired.
Operator	Name of the user who will be using the new traverse, if desired.
Method	<p>B'F'F''B'' All points are measured in face I, then all points are measured in face II in reverse sequential order.</p> <p>B'B''F''F' The backsight point is measured in face I immediately followed by face II. Other points are measured in alternating face order.</p> <p>B'F' All points are measured in face I only.</p>
No. of Sets	Number of sets. Limited to 10.
Use Face-Tol.	Important when measuring with face I and II. This checks if both measurements are within a defined limit. If the limit is exceeded, a warning message is displayed.
Face-Tol.	The limit that will be used for checking the face tolerance.

Next step

Press **Cont** to confirm the traverse configuration and proceed to the **Traverse-Select** screen.

Measure Traverse - Enter Station Data

Field	Description
Stat. ID	Name of the station.
hi	Height of the instrument.
Desc.	Description of the station, if desired.



Every Traverse must start on a known point.

Next step

Press **Cont** to confirm station data and proceed to the **Traverse-Select** screen.

11.14.3

Measuring Traverse

Access

From the **Traverse-Select** screen select one of the following:

- **F1...w/o known Backsight:** Starts the traverse without a known backsight. The measurements begin to a foresight point.
- **F2...with known Backsight:** Starts the traverse with a known backsight.
- **F3...with known Azimuth:** Starts the traverse with a user-defined azimuth.

Without known backsight

Start a traverse without a known backsight

- Start on a known point without an initial measurement to a known backsight.
- Stop on a known point, or make a final foresight measurement to a known closing point.

If the coordinates of the start station are unknown, the Station Setup program can be run before the traverse. A Helmert transformation will be performed at the end of the traverse.

If the traverse is left open, then the calculations are based on the system azimuth.

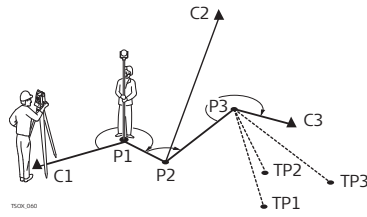

C1, C3 Control points
 C2 Check point
 P1-P3 Traverse points
 TP1-TP3 Topographic points

With known backsight

Start a traverse with a known backsight

- Start on a known point with an initial measurement to a known backsight.
- Stop on a known point and optionally measure to a known closing point.

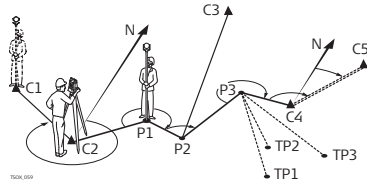

C1, C2 Control points
 C4, C5 Control points
 C3 Check point
 P1...P3 Traverse points
 TP1...TP3 Topographic points
 N North direction

With known azimuth

Start a traverse with a known azimuth

- Start on a known point, aim to any direction (for example a tower) and define this direction as the reference. This method is often used to define a 0-direction.
- Stop/end the traverse either on a known point or a traverse point and then measure to a known closing point, or leave the traverse open. Refer to "11.14.5 Closing a Traverse".

If using the current system azimuth, for example from the Stn.Setup program, then simply confirm the suggested Hz-value in the **Set Horizontal Angle** screen.

Measure traverse - Sight Backsight!

Field	Description
BS ID	Point ID of the backsight point.
Remark	Description of the backsight point.
Stat.ID	Name of the station.

Next step

Depending on the traverse method configured, after the measurement either the **Sight Backsight!** screen stays active for measuring the backsight point in a second face, or the **Sight Foresight!** screen appears for measuring the foresight point.

Measure traverse - Sight Foresight!

Next step

Depending on the traverse method configured, after the measurement either the **Sight Foresight!** screen stays active for measuring the foresight point in a second face, or the **Sight Backsight!** screen appears for measuring the backsight point.

Interrupt a set

To interrupt a set, press **ESC** to exit the backsight or foresight screen. The **Continue with...** screen will appear.

Continue with...

Field	Description
F1 Redo last measurement	Returns to last measured point, can be either a backsight or a foresight point. The last measurement is not stored.
F2 Redo whole station	Returns to first sight point screen. The data from the last station is not stored.
F3 Exit Traverse	Returns to the Apps menu. The traverse stays active and can be continued later. The data from the last station is lost.
F4 Back	Returns to the previous screen where ESC was pressed.

Repetitive loop for the number of sets

Alternating between screens for the backsight and foresight measurements continues according to the configured number of sets.

The number of sets and the face are indicated in the top right corner of the screen. For example 1/I means set 1 in face I.

11.14.4

Moving ahead

Number of defined sets is achieved

When the number of defined sets is achieved, the **Traverse-Select** screen is displayed automatically. The accuracy of the set measurements is checked. The set can be accepted or redone.

Moving ahead with the traverse

From the **Traverse-Select** screen, select an option to move ahead with the traverse, or press **ESC** to redo the last station.

Field	Description
F1 Survey Sideshot	Enables the measurement of standard survey and topographic points. Measured points are stored with a Traverse flag. If the traverse is finally adjusted, these points will be updated. Close: To exit the Measure Sideshot! screen and returns to the Traverse-Select screen.
F2 Move to next Station	Move to the next station. The instrument can either be left on or turned off. If the instrument is turned off and then turned on again later, the message Last traverse not yet finished or processed! Do you really want to start a new traverse? All existing data will be overwritten! will display. Selecting Yes will re-open the Traverse to continue at the new station. The start screen for the next station is similar to the Enter Station Data screen. The point ID of the foresight point of the last station is suggested as station ID automatically. Run through the loop of backsight and foresight measurements until the number of sets is reached.
F3 Measure Checkpoint	By measuring a check point it is possible to check whether the Traverse is still within certain deviations. A check point is excluded from the traverse calculation and adjustment, however, all measurement data and results observed from a check point are stored. <ol style="list-style-type: none">1. Enter the name of the check point and the height of the reflector.2. Press Cont to go to the next screen.3. Measure the check point. The differences in Easting, Northing and Height are displayed.

Field	Description
	A message will appear if the tolerances defined in the Traverse configuration are exceeded.

Next step

Close the traverse by selecting **Close** in the **Sight Foresight!** screen after a backsight point measurement, but before the foresight point measurement.

11.14.5

Closing a Traverse

Access

Close the traverse by selecting **Close** in the **Sight Foresight!** screen after a backsight point measurement, but before the foresight point measurement.

Close Traverse...

Field	Description
F1...at Known Station to Known Closing Point	To close a traverse at a known station to a known closing point. Use when setup on the closing station, and the coordinates for the station and the closing point are known.  If this method is chosen a distance measurement is mandatory. <ol style="list-style-type: none">1. Input the data for both points.2. Measure to the closing point.3. The results are displayed.
F2...to Known Closing Point	To close a traverse to a known closing point. Use when setup on an unknown station and only the coordinates of the closing point are known. <ol style="list-style-type: none">1. Input the data for the point.2. Measure to the closing point.3. The results are displayed.
F3...at Known Station Only	To close a traverse at a known station only. Use when setup on the closing station and the coordinates for it are known. <ol style="list-style-type: none">1. Input the data for the closing station.2. The results are displayed.
F4...Leave Open	To leave the traverse open. There is no last traverse station. <ol style="list-style-type: none">1. The results are displayed.

Next step

Select an option, from the **Close Traverse...** menu to proceed to the **Traverse Results** screen.

Traverse results

Field	Description
Traverse ID	Name of the traverse.
Start Stn.	Point ID of the start station.
End Stn.	Point ID of the end station.
No.of Stn.	Number of stations in the traverse.
Total Dist.	Total distance of the traverse.
1D Accuracy	Accuracy in 1D $1/\left(\frac{\text{Length of Traverse}}{\text{Height Misclosure}} \right)$

Field	Description
2D Accuracy	Accuracy in 2D $1/\left(\frac{\text{Length of Traverse}}{\text{Linear Misclosure}}\right)$
L of Error	Length/distance error.
Azimuth Err.	Azimuth closure error.
DeltaEast, DeltaNorth, DeltaHeight	Calculated coordinates.

Next step

Press **Adjust** from the **Traverse Results** screen to calculate the adjustments.

Set adjustment parameter

Field	Description
No.of Stn.	Number of stations in the traverse.
Azimuth Err.	Azimuth closure error.
Misc.-Distr.	For misclosure distribution.  Angle misclosures are distributed equally.
	Compass For surveys where angles and distances were measured with equal precision.
	Transit For surveys where angles were measured with a higher precision than the distances.
Height-Distr	The height error can be distributed equally, by distance or not at all.
Scale	PPM value defined by the calculated distance between start and end point divided by the distance measured.
Use Scale	Whether to use the calculated ppm.



- Depending on the number of measured points the calculation may take some time. A message is displayed during the processing.
- Adjusted points are stored as fixpoints with an additional prefix, for example point BS-154.B is stored as CBS-154.B.
- After the adjustment, the Traverse program is exited and the system returns to the **Main Menu**.

Messages

The following are important messages or warnings that may appear.

Messages	Description
Memory is nearly full! Do you want to continue?	This message occurs if less than 10% of the memory is free. It is not recommended to start a traverse if the memory is almost full. Doing so, may mean that the traverse measurements and the results cannot be saved.
Current job contains an adjusted Traverse. Select a different job!	Only one traverse per job is allowed. Another job must be selected.
Last traverse not yet finished or processed! Do you want to continue?	The Traverse program was quit without closing a traverse. The traverse can be continued on a new station, left unfinished, or a new traverse started and the old traverse data overwritten.

Messages	Description
Do you really want to start a new traverse? All existing data will be overwritten!	Confirmation of this message will start a new traverse and the old traverse data will be overwritten.
Redo last station? Measurements of this station will be overwritten!	Confirming returns to the first sight point screen for the previous station measurements. The data from the last station is not stored.
Exit Traverse application? Current station data will be lost!!!	Quitting the program returns to the Main Menu . The traverse can be continued later, but the current station data will be lost.
Out of Tolerance!	The tolerance limits have been exceeded. If not accepted, the calculations can be redone.
Traverse points are re-calculated and newly stored...	An information message displayed while the adjustment is calculated.

12

Data Management

12.1

Data Management

Access

Select **Data** from the **MAIN MENU**.

DATA MANAGEMENT

The Data Management menu contains all functions for entering, editing, checking and deleting data in the field.

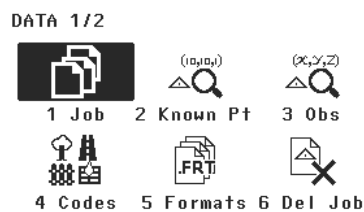

1 - 6

To select menu item.

Menu item	Description
Job	To view, create and delete jobs. Jobs are a summary of data of different types, for example, known points, observations or codes. The job definition consists of the job name and user. The system generates time and date at the time of creation.
Known points	To view, create, edit and delete known points. Valid known points contain at least the point ID and the coordinates E, N or Z.
Observations	To view and delete observation data. Observation data available in the internal memory can be searched for via a specific point search, or by viewing all points within a job.
Code Library	To view, create, edit and delete codes. To each code a description and a maximum of 8 attributes with up to 16 characters each can be assigned.
Formats	To view and delete data format files.
Erase Job Memory	To delete individual jobs, known points and measurements of a specific job or all jobs in the memory.  Deleting the memory cannot be undone. After confirming the message all data is permanently deleted.
USB-Explorer	To view, delete, rename and create folders and files stored on the USB memory stick. Refer to "12.4 Working with a USB Memory Stick" and "B Directory Structure".

Next step

- Either, select a menu option using **1 - 6**.
- Or, press **ESC** to return to the **MAIN MENU**.

12.2

Exporting Data

Description

Job data can be exported from the internal memory of the instrument. Data can be exported via:

The RS232 serial interface

A receiver, such as a laptop, is connected to the RS232/USB port. The receiver requires GGO Data Exchange Manager or another third party software.



If the receiver is too slow in processing data the data could be lost. With this type of data transfer the instrument is not informed about the performance of the receiver (no protocol). Therefore the success of this type of transfer is not checked.

A USB memory stick

A USB memory stick can be inserted and removed from the USB host port. No additional software is required for the transfer.

Access

1. Select **Trans** from the **MAIN MENU**.
2. Select **Export** from the **DATA IMPORT & EXPORT** menu.

DATA EXPORT

- SEARCH** To search for jobs within the internal memory.
- DISPL.** To list all jobs within the internal memory.

Field	Description
To	USB memory stick or RS232 serial interface.
Data Type	Data type to be transferred to Interface: Observations, KnownPts or Observ. &KnownPts. Data type to be transferred to USB-Stick: Observations, KnownPts, Observ. &KnownPts, Road Data, Code, Format, Configuration, Backup.
Select Job	Displays the selected job file.

Export data step-by-step

1. Press **OK** in the **DATA EXPORT** screen after selecting the export details.
2. Select the data format and press **OK** or **SEND**.



The **ASCII** data format is only available for data exports to a USB memory stick, not via the RS232 serial interface.



All jobs will be stored in the backup folder created on the USB memory stick. The job data will be stored as individual database files for each job, which can then be imported again. Refer to "12.3 Importing Data".

Exportable job data formats

Job data can be exported from a job in a variety of file types. A format can be defined in GGO Format Manager. Refer to the online help of GGO for information on creating format files.

RS232 example job data output

Within the **Data Type** setting **Observations**, a data set could be shown as follows:

11....+00000D19	21..022+16641826	22..022+09635023
31..00+00006649	58..16+00000344	81..00+00003342

GSI-IDs		GSI-IDs continued	
11	△ Pt	41-49	△ Codes and attributes
21	△ Horizontal direction	51	△ ppm and Prism constant
22	△ Vertical angle	58	△ Prism constants
25	△ Orientation	81-83	△ (E, N, Z) Target point
31	△ Slope distance	84-86	△ (E, N, Z) Station point
32	△ Horizontal distance	87	△ Reflector height
33	△ Height difference	88	△ Instrument height

12.3

Importing Data

Description

Data can be imported to the internal memory of the instrument via a USB memory stick.

Importable data formats

When importing data, the instrument automatically stores the file in a directory folder based on the file extension. The following data formats can be imported:

Data Type	File extension	Recognised as
DXF	.dxf	Known points
GSI	.gsi	Known points
Format	.fmt	Format file
Codelist	.cls	Codelist file

Access

1. Select **Trans** from the **MAIN MENU**.
2. Select **Import** from the **DATA IMPORT & EXPORT** menu.

DATA IMPORT

```

DATA IMPORT

From:          USB-Stick
To :           Instrument
File:          Single File
  
```

BACK OK

Field	Description
From	USB-Stick
To	Instrument

Field	Description
File	Single File

Import data step-by-step

1. Press **OK** in the **DATA IMPORT** screen to proceed to the USB memory stick file directory.
2. Select the file on the USB memory stick to be imported and press **OK**.
3. Define the Job name for the imported file, and, if requested, the file definition and layers, and press **OK** to import. If a Job with the same name already exists in the internal memory, a message will appear with the options to overwrite the existing job or rename the job for the file being imported.
4. A message will display once the file has been successfully imported.

12.4

Working with a USB Memory Stick

Insert a USB memory stick step-by-step

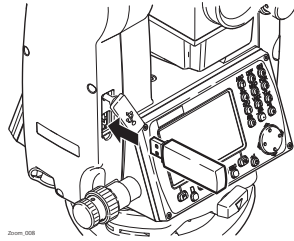

Lift the lid covering the USB host port on the instrument.

Insert the USB memory stick into the USB host port.



Always return to the **Main Menu** before removing the USB memory stick.



GeoMax cannot be held responsible for data loss or any other error that may occur when using a USB memory stick.



- Keep the USB memory stick dry.
- Use it only within the specified temperature range.
- Protect the USB memory stick from direct impacts.

Failure to follow these instructions could result in data loss and/or permanent damage to the USB memory stick.

12.5

Working with Bluetooth

Description

The instruments can communicate with external devices via a Bluetooth connection. The instrument Bluetooth is a slave only. The Bluetooth of the external device will be the master, and therefore will control the connection and any data transfer.

Establishing a connection step-by-step

1. On the instrument ensure that the communication parameters are set to **Bluetooth** and **On**. Refer to "5.3 Communication Settings".
 2. Activate Bluetooth on the external device. The steps required depend on the Bluetooth driver and other device specific configurations. Refer to the device user manual for information on how to configure and search for a Bluetooth connection.
 3. The instrument will appear on the external device. Some devices ask for the identification number of the Bluetooth. The default number for a Zoom Bluetooth is 0000. This can be changed by:
 1. Select **Settings** from the **MAIN MENU**.
 2. Select **Comm.** from the **SETTINGS** menu.
 3. Press **BTCode** from the **COMMUNICATION SETTINGS** screen.
 4. Enter a new Bluetooth code in **BT-Code:**
 5. Press **OK** to confirm the new Bluetooth code.
 4. When the external Bluetooth device has located the instrument for the first time, a message will display on the instrument stating the name of the external device and requesting confirmation that connection to this device should be allowed.
 1. Press **YES** to allow, or
 2. Press **NO** to disallow this connection.
 5. The instrument Bluetooth sends out the instrument name and serial number to the external Bluetooth device.
 6. All further steps must be made in accordance to the user manual of the external device.
-

13

Calibration

13.1

Overview

Description

GeoMax instruments are manufactured, assembled and adjusted to a high quality. Quick temperature changes, shock or stress can cause deviations and decrease the instrument accuracy. It is therefore recommended to calibrate the instrument from time to time. This can be done in the field by running through specific measurement procedures. The procedures are guided and have to be followed carefully and precisely as described in the following chapters. Some other instrument errors and mechanical parts can be adjusted mechanically.

Electronic calibration

The following instrument errors can be checked and calibrated electronically:

- Horizontal collimation error, also called line-of-sight error.
- Vertical index error, and simultaneously the electronic level.
- Compensator longitudinal and transversal index errors.



For determining these errors, it is necessary to measure in both faces, but the procedure can be started in any face.

Mechanical calibration

The following instrument parts can be calibrated mechanically:

- Circular level on the instrument and tribrach.
- Laser plummet.
- Screws on the tripod.



During the manufacturing process, the instrument errors are carefully determined and set to zero. As mentioned, these errors can change and it is highly recommended to redetermine them in the following situations:

- Before the instrument is used for the first time.
- Before every high precision survey.
- After rough or long periods of transport.
- After long periods of work or storage.
- If the temperature difference between current environment and the temperature at the last calibration is more than 10°C (18°F).

13.2

Preparation



Before determining the instrument errors, level-up the instrument using the electronic level. The **Level & Plummet** is the first screen to appear after turning on the instrument. The tribrach, the tripod and the ground should be very stable and secure from vibrations or other disturbances.



The instrument should be protected from direct sunlight in order to avoid thermal expansion on one side only.



Before starting to work, the instrument has to become acclimatised to the ambient temperature. Approximately two minutes per °C of temperature difference from storage to working environment, but at least 15 min, should be taken into account.

13.3

Calibrating Line-of-Sight and Vertical Index Error

Line-of-sight error

The line-of-sight error, or horizontal collimation error is the deviation from the perpendicular between the tilting axis and the line of sight. The effect of the line-of-sight error to the horizontal direction increases with the vertical angle.

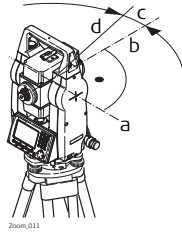

- a Tilting axis
- b Line perpendicular to tilting axis
- c Horizontal collimation, or line-of-sight, error
- d Line-of-sight

Vertical index error

The vertical circle should read exactly 90° (100 gon) when the line of sight is horizontal. Any deviation from this figure is termed vertical index error. This is a constant error that affects all vertical angle readings.

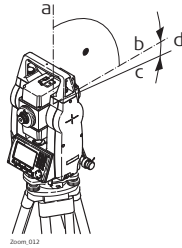

- a Mechanical vertical axis of the instrument, also called standing axis
- b Axis perpendicular to the vertical axis. True 90°
- c Vertical angle is reading 90°
- d Vertical index error



By determining the vertical index error the electronic level is adjusted automatically

Access

1. Select **Tools** from the **MAIN MENU**.
2. Select **Calibr.** from the **TOOLS MENU**.
3. Select **HA-collimation** or **Vertical Index**.



The procedures and conditions required to correct line-of-sight and vertical index errors are the same, therefore the procedure will only be described once.

Calibration step-by-step

1. Level the instrument with the electronic level. Refer to "Level up with the electronic level step-by-step".
2. Aim at a point approximately 100 m from the instrument which is within 5° of the horizontal.

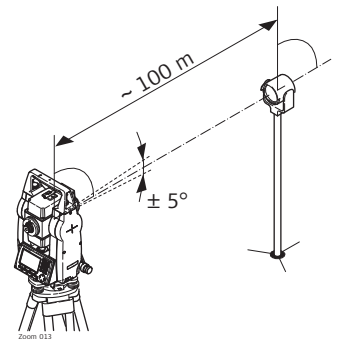

3. Press **REC** to measure to the target point.
4. Change face and aim at the target point again

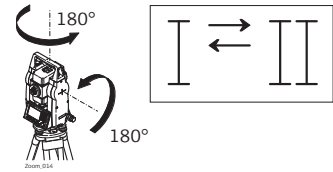

For checking the horizontal aim, the difference in HA and VA are displayed.

5. Press **REC** to measure to the target point.



The old and new calculated values are displayed.

6. Either:
 - Press **OK** to save the new calibration data, or
 - Press **ESC** to exit without saving the new calibration data.

Messages

The following are important messages or warnings that may appear.

Messages	Description
VA-angle not suitable for adjustment !	The vertical angle deviates from the required horizontal / line-of-sight, or in face II the vertical angle deviates by more than 5° from the target point. Aim at the target point with an accuracy of min. 5°. Confirmation of the message required.
Results out of tolerance. Previous values retained !	Computed values out of tolerance. The previous values are retained and measurements should be repeated. Confirmation of the message required.
HA-angle not suitable for adjustment !	Horizontal angle in face II deviates by more than 5° from the target point. Aim on the target point with an accuracy of min. 5°. Confirmation of the message required.
Measurement Error. Try again.	Measurement error appears when, for example, there is an unstable set up. Repeat the process. Confirmation of the message required.
Time limit exceeded ! Please repeat adjustment !	Time difference between measurements for results storage exceeds 15 minutes. Repeat the process. Confirmation of the message required.

Compensator index error

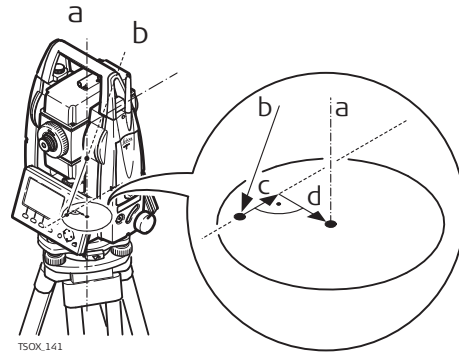

- a Mechanical vertical axis of the instrument, also called standing axis
- b Plumb line
- c Longitudinal component (l) of the compensator index error
- d Transversal component (t) of the compensator index error

The compensator index errors (l, t) occur, if the vertical axis of the instrument and the plumb line are parallel but the zero points of the compensator and the circular level do not coincide. The calibration procedure electronically adjusts the zero point of the compensator.

A longitudinal component in direction of the telescope and a transversal component perpendicular to the telescope define the plane of the dual axis compensator of the instrument.

The longitudinal compensator index error (l) has a similar effect as the vertical index error and effects all vertical angle readings.

The transversal compensator index error (t) is similar to the tilting axis error. The effect of this error to the horizontal angle readings is 0 at the horizon and increases with steep sightings.

Access

1. Select **Tools** from the **MAIN MENU**.
2. Select **Calib.** from the **TOOLS** menu.
3. Select **Comp. Index**.

Check and adjust step-by-step

Step	Description
1.	Level the instrument with the electronic level. Refer to - "Level up with the electronic level step-by-step".
2.	Press REC to measure the first face. No target has to be aimed at.
3.	REC to release the measurement in the other face.
	If one or more errors are bigger than the predefined limits, the procedure must be repeated. All measurements of the current run are rejected and are not averaged with the results from previous runs.
4.	Measure the target. The standard deviations of the determined adjustment errors can be calculated from the second run onwards.

13.5

Calibrating the Circular Level of the Instrument and Tribrach

Calibrate the circular level step-by-step

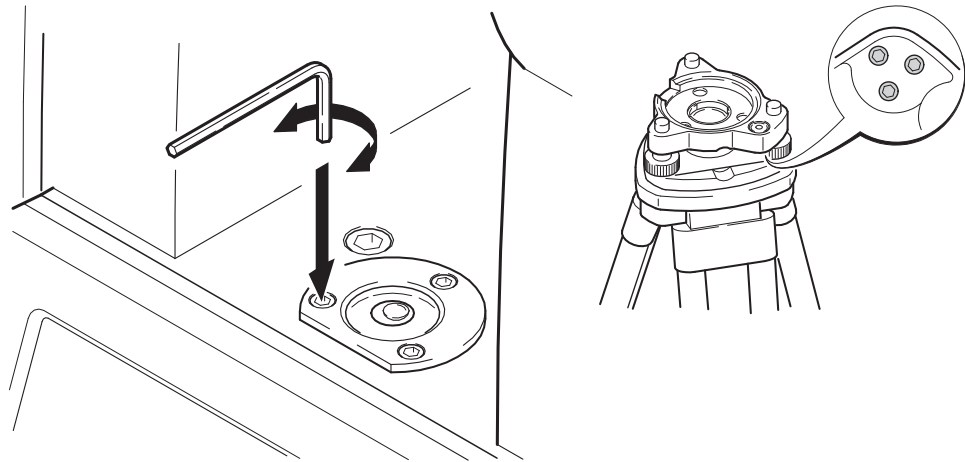

- 1 Place and secure the tribrach onto the tripod, and then secure the instrument onto the tribrach.
- 2 Using the tribrach footscrews, level the instrument with the electronic level. To activate the electronic level, turn on the instrument, and, if tilt correction is set to 1- or 2-axis, the **Level & Plummet** screen appears automatically. Alternatively, press **FNC** from within any application and select **Level & Plummet**.
- 3 The bubbles of the instrument and tribrach levels must be centered. If one or both circular levels are not centered, adjust as follows.

Instrument: If the bubble extends beyond the circle, use the Allen key supplied to center it with the adjustment screws.

Tribrach: If the bubble extends beyond the circle, adjust it using the adjustment pin in conjunction with the adjustment screws. Turn the adjustment screws:

- To the left: and the bubble approaches the screw.
- To the right: and the bubble goes away from the screw.

- 4 Repeat step 3 on the instrument and tribrach until both circular levels are centered and no further adjustments are necessary.



After the calibration, no adjustment screw should be loose.

13.6

Inspecting the Laser Plummet of the Instrument



The laser plummet is integrated into the vertical axis of the instrument. Under normal conditions of use, the laser plummet does not need adjusting. If an adjustment is necessary due to external influences, the instrument has to be returned to a GeoMax service department.

Inspect the laser plummet step-by-step

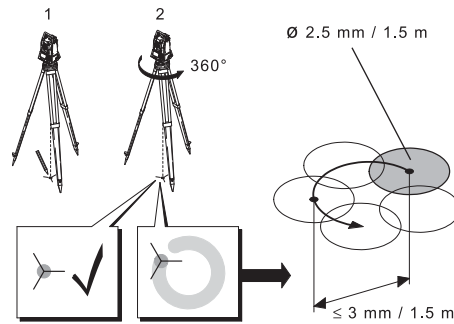

- 1 Set up the instrument on the tripod approximately 1.5m above the ground and level up.
- 2 To activate the laser plummet, turn on the instrument, and, if tilt correction is set to 1- or 2-axis, the laser plummet will be activated automatically, and the **Level & Plummet** screen appears. Otherwise, press **FNC** from within any application and select **Level & Plummet**.

☞ Inspection of the laser plummet should be carried out on a bright, smooth and horizontal surface, such as a sheet of paper.

- 3 Mark the center of the red laser dot on the ground.
- 4 Turn the instrument slowly through 360°, carefully observing the movement of the red laser dot.

☞ The maximum diameter of the circular movement described by the center of the laser dot should not exceed 3mm at a height of 1.5m.

- 5 If the center of the laser dot makes a clearly circular movement, or moves more than 3mm away from the point which was first marked, an adjustment may be required. Call your nearest GeoMax service centre. Depending on brightness and surface type, the size of the laser dot can vary. At a height of 1.5m an average diameter of 2.5mm is estimated.

13.7

Servicing the Tripod

Service the tripod step-by-step

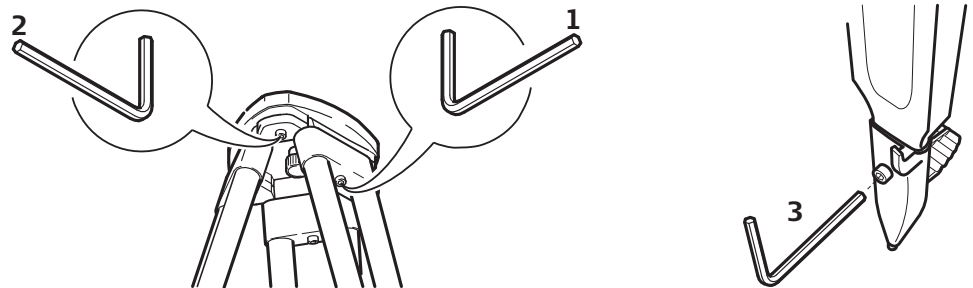

☞ The connections between metal and timber components must always be firm and tight.

1. Tighten the leg cap screws moderately with the allen key supplied.
2. Tighten the articulated joints on the tripod head just enough to keep the tripod legs open when lifting the tripod off the ground.
3. Tighten the screws of the tripod legs.

14

Care and Transport

14.1

Transport

Transport in the field

When transporting the equipment in the field, always make sure that you

- either carry the product in its original container,
 - or carry the tripod with its legs splayed across your shoulder, keeping the attached product upright.
-

Transport in a road vehicle

Never carry the product loose in a road vehicle, as it can be affected by shock and vibration. Always carry the product in its container, original packaging or equivalent and secure it.

Shipping

When transporting the product by rail, air or sea, always use the complete original GeoMax packaging, transport container and cardboard box, or its equivalent, to protect against shock and vibration.

Shipping, transport of batteries

When transporting or shipping batteries, the person responsible for the product must ensure that the applicable national and international rules and regulations are observed. Before transportation or shipping, contact your local passenger or freight transport company.

Field adjustment

Periodically carry out test measurements and perform the field adjustments indicated in the User Manual, particularly after the product has been dropped, stored for long periods or transported.

14.2

Storage

Product

Respect the temperature limits when storing the equipment, particularly in summer if the equipment is inside a vehicle. Refer to for information about temperature limits.

Field adjustment

After long periods of storage inspect the field adjustment parameters given in this user manual before using the product.

Li-Ion batteries

- Refer to " Environmental specifications" for information about storage temperature range.
 - Remove batteries from the product and the charger before storing.
 - After storage recharge batteries before using.
 - Protect batteries from damp and wetness. Wet or damp batteries must be dried before storing or use.
 - A storage temperature range of 0 °C to +30 °C / +32 °F to +86 °F in a dry environment is recommended to minimize self-discharging of the battery.
 - At the recommended storage temperature range, batteries containing a 40% to 50% charge can be stored for up to one year. After this storage period the batteries must be recharged.
-

14.3

Cleaning and Drying

Objective, eyepiece and reflectors

- Blow dust off lenses and prisms.
 - Never touch the glass with your fingers.
 - Use only a clean, soft, lint-free cloth for cleaning. If necessary, moisten the cloth with water or pure alcohol. Do not use other liquids; these may attack the polymer components.
-

Fogging of prisms

Prisms that are cooler than the ambient temperature tend to fog. It is not enough simply to wipe them. Keep them for some time inside your jacket or in the vehicle to allow them to adjust to the ambient temperature.

Damp products

Dry the product, the transport container, the foam inserts and the accessories at a temperature not greater than 40°C /104°F and clean them. Remove the battery cover and dry the battery compartment. Do not repack until everything is completely dry. Always close the transport container when using in the field.

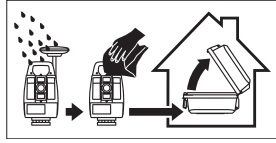

Cables and plugs

Keep plugs clean and dry. Blow away any dirt lodged in the plugs of the connecting cables.

Connectors with dust caps

Wet connectors must be dry before attaching the dust cap.

15

Technical Data

15.1

Angle Measurement

Accuracy

Available angular accuracies	Standard deviation HA, VA, ISO 17123-3	Display resolution				
		[""]	[mgon]	[""]	[°]	[mgon]
1	0.3	1	0.0001	0.1	0.01	
2	0.6	1	0.0001	0.1	0.01	
5	1.5	1	0.0001	0.1	0.01	

Characteristics

Absolute, continuous, diametric. Updates each 0.1 to 0.3 s.

15.2

Distance Measurement with Reflectors

Range

Reflector	Range A		Range B		Range C	
	[m]	[ft]	[m]	[ft]	[m]	[ft]
Standard prism	1800	6000	3000	10000	3500	12000
3 prisms						
N5	2300	7500	3000	10000	3500	12000
A5/A10	2300	7500	4500	14700	5400	17700
Reflector foil 60 mm x 60 mm	150	500	250	800	250	800

Shortest measuring distance: 1.5m

Atmospheric conditions

Range	Description
A	Strong haze, visibility 5km; or strong sunlight, severe heat shimmer
B	Light haze, visibility about 20km; or moderate sunlight, slight heat shimmer
C	Overcast, no haze, visibility about 40km; no heat shimmer

Accuracy

Accuracy refers to measurements to standard reflectors.

EDM measuring mode	Standard deviation ISO17123-4	Measurement time, typical [s]	
		Zoom25	Zoom50
IR-Default	2mm + 2ppm	2.4	2.4
IR-Quick	3mm + 2ppm	2.0	1.0
IR-Continuous	3mm + 2ppm	0.33	0.3
Foil	3mm + 2ppm	2.4	2.4

Beam interruptions, severe heat shimmer and moving objects within the beam path can result in deviations of the specified accuracy.

Characteristics

Principle:	Phase measurement		
Type:	Coaxial, visible red laser		
Carrier wave:	658nm		
Measuring system:	Zoom25:	Distance measurement system using phase-shift principle with frequency 320MHz	
	Zoom50:	System analyser basis 100 MHz - 150 MHz	

15.3

Distancer, Measurements without Reflectors (Reflectorless mode)

Range

N5/A5 (without reflector)

Kodak Gray Card	Range D		Range E		Range F	
	[m]	[ft]	[m]	[ft]	[m]	[ft]
White side, 90% reflective	250	820	400	1312	>500	>1640
Grey side, 18% reflective	100	330	150	490	>250	>820

A10 (without reflector)

Kodak Gray Card	Range D		Range E		Range F	
	[m]	[ft]	[m]	[ft]	[m]	[ft]
White side, 90% reflective	600	1970	800	2630	≤1000	≤3280
Grey side, 18% reflective	300	990	400	1310	≤500	≤1640

Range of Measurement:	1.5m to 1200m
Display unambiguous:	up to 1200m

Atmospheric conditions

Range	Description
D	Object in strong sunlight, severe heat shimmer
E	Object in shade, or overcast
F	Underground, night and twilight

Accuracy

Standard measuring	ISO 17123-4	Measure time, typical [s]	Measure time, maximum [s]
0m - 500m	2mm + 2ppm	3 - 6	15
>500m	4mm + 2ppm	3 - 6	15

Beam interruptions, severe heat shimmer and moving objects within the beam path can result in deviations of the specified accuracy.

Continuous measuring*	Standard deviation	Measure time, typical [s]	
		Zoom25	Zoom50
Continuous	5mm + 3ppm	1.00	0.25

* Accuracy and measure time depend on atmospheric conditions, target object and observation situation.

Characteristics

Type:	Coaxial, visible red laser		
Carrier wave:	658nm		
Measuring system:	Zoom25:	Distance measurement system using phase-shift principle with frequency 320MHz	
	Zoom50:	System analyser basis 100 MHz - 150 MHz	

Laser dot size

Distance [m]	Laser dot size, approximately [mm]
at 30	7 x 10
at 50	8 x 20
at 100	16 x 25

15.4

Distance Measurement Reflector (Long Range)



This chapter is valid for Zoom50 only.

Range

Reflector	Range A		Range B		Range C	
	[m]	[ft]	[m]	[ft]	[m]	[ft]
Standard prism	2200	7300	7500	24600	>10000	>33000
Reflector foil 60mm x 60mm	600	2000	1000	3300	1300	4200

Range of measurement: From 1000m up to 12000m

Display unambiguous: Up to 12km

Atmospheric conditions

Range	Description
A	Strong haze, visibility 5km; or strong sunlight, severe heat shimmer
B	Light haze, visibility about 20km; or moderate sunlight, slight heat shimmer
C	Overcast, no haze, visibility about 40km; no heat shimmer

Accuracy

Standard measuring	ISO 17123-4	Measure time, typical [s]	Measure time, maximum [s]
Long range	5mm + 2ppm	2.5	12

Beam interruptions, severe heat shimmer and moving objects within the beam path can result in deviations of the specified accuracy.

Characteristics

Type	Description
Principle	Phase measurement
Type	Coaxial, visible red laser
Carrier wave	658nm
Measuring system	System Analyzer Basis 100MHz - 150MHz

15.5

Conformity to National Regulations

Conformity to national regulations

- FCC Part 15 (applicable in US).
- Hereby, GeoMax AG, declares that the radio equipment type Zoom25/Zoom50 is in compliance with the Directive 2014/53/EU and other applicable European Directives. The full text of the EU declaration of conformity may be consulted at <http://www.geomax-positioning.com/Downloads.htm>.



Class 1 equipment according European Directive 2014/53/EU (RED) can be placed on the market and be put into service without restrictions in any EEA Member state.

- The conformity for countries with other national regulations not covered by the FCC part 15 or European directive 2014/53/EU has to be approved prior to use and operation.

Frequency band

2402 - 2480 MHz

Output power

Bluetooth: 2.5 mW

15.5.1

Dangerous Goods Regulations

Dangerous Goods Regulations

The products of GeoMax are powered by Lithium batteries.

Lithium batteries can be dangerous under certain conditions and can pose a safety hazard. In certain conditions, Lithium batteries can overheat and ignite.



When carrying or shipping your GeoMax product with Lithium batteries onboard a commercial aircraft, you must do so in accordance with the **IATA Dangerous Goods Regulations**.



GeoMax has developed **Guidelines** on "How to carry GeoMax products" and "How to ship GeoMax products" with Lithium batteries. Before any transportation of a GeoMax product, we ask you to consult these guidelines on our web page (<http://www.geomax-positioning.com/dgr>) to ensure that you are in accordance with the IATA Dangerous Goods Regulations and that the GeoMax products can be transported correctly.



Damaged or defective batteries are prohibited from being carried or transported onboard any aircraft. Therefore, ensure that the condition of any battery is safe for transportation.

15.6

General Technical Data of the Product

Telescope

Type	Value
Magnification	30x
Free Objective aperture	40mm
Focusing	1.7m/5.6ft to infinity
Field of view	1°30'/1.66gon 2.7m at 100m

Compensation

Quadruple axis compensation (2-axis compensator with HA-collimation and VA-Index).

Angular accuracy	Setting accuracy		Setting range	
	[""]	[mgon]	[']	[gon]
1	0.5	0.2	±4	0.07
2	0.5	0.2	±4	0.07
5	1.5	0.5	±4	0.07

Level

Type	Value
Circular level sensitivity	6'/2mm
Electronic level resolution	2"

Control unit

Type	Value
B&W display:	280 x 160 pixels, LCD, backlit, 8 lines with 30 characters each, heatable (temp. <-5°).
C&T display:	320 x 240 pixels (QVGA), LCD, backlit, 10 lines with 30 characters each, keyboard illumination

Instrument Ports

Name	Description
Serial/USB	6 pin Hirose for power, communication, data transfer. This port is located at the base of the instrument.
USB host port	USB memory stick port for data transfer.
Bluetooth	Bluetooth connections for communication and data transfer.

Instrument dimensions

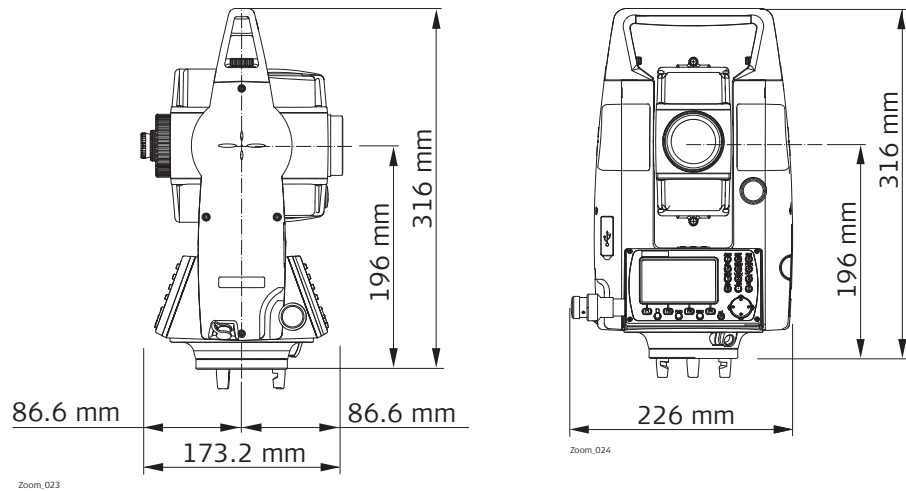

Weight

Type	Value
Instrument:	4.2 kg - 4.5 kg (depending on hardware configuration)
Tribrach:	760 g
Battery ZBA400:	110 g

Tilting axis height

Type	Value
Without tribrach:	196 mm
With tribrach:	240 mm ±5 mm

Recording

Memory Type	Number of measurements
Internal memory	50,000

Laser plummet

Type	Value
Type	Visible red laser class 2
Location	In standing axis of instrument
Accuracy	Deviation from plumb line: 1.5mm (2 sigma) at 1.5m instrument height
Diameter of laser point	2.5mm at 1.5m instrument height

Power

Type	Value
External supply voltage via serial interface	Nominal voltage 12.8 V DC, Range 11.5 V-14 V

Battery ZBA400

Type	Value
Type	Li-Ion
Voltage	7.4 V
Capacity	4.4 Ah
Operating time	approximately 16 hours Based on a single measurement every 30 s at 25 °C. Operating time may be shorter if battery is not new.

Environmental specifications

Temperature

Type	Operating temperature		Storage temperature	
	[°C]	[°F]	[°C]	[°F]
Zoom instrument	-20 to +50	-4 to +122	-40 to +70	-40 to +158
Battery	-20 to +50	-4 to +122	-40 to +70	-40 to +158

Protection against water, dust and sand

Type	Protection
Zoom instrument	IP55 (IEC 60529) Dust-proof and complete protection against contact and water jets.

Humidity

Type	Protection
Zoom instrument	Max 95% non condensing. The effects of condensation are to be effectively counteracted by periodically drying out the instrument.

Automatic corrections

The following automatic corrections are made:

- Line of sight error
- Tilting axis error
- Earth curvature
- Standing axis tilt
- Vertical index error
- Refraction
- Compensator index error
- Circle eccentricity

15.7

Scale Correction

Use of scale correction

By entering a scale correction, reductions proportional to distance can be taken into account.

- Atmospheric correction.
- Reduction to mean sea level.
- Projection distortion.

Atmospheric correction

The slope distance displayed is correct if the scale correction in ppm, mm/km, which has been entered corresponds to the atmospheric conditions prevailing at the time of the measurement.

The atmospheric correction includes:

- Adjustments for air pressure
- Air temperature

For highest precision distance measurements, the atmospheric correction should be determined with:

- An accuracy of 1ppm
- Air temperature to 1°C
- Air pressure to 3mbar

**Atmospheric corrections
°C**

Atmospheric corrections in ppm with temperature [°C], air pressure [mb] and height [m] at 60 % relative humidity.

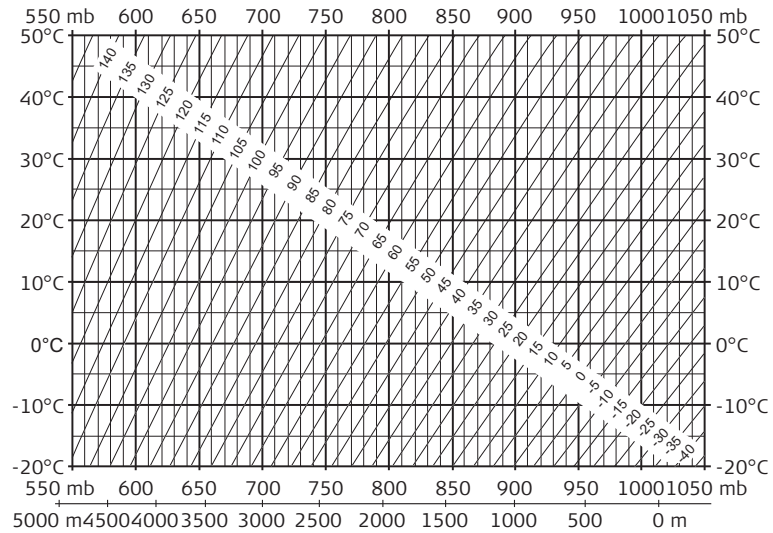

Atmospheric correction °F

Atmospheric corrections in ppm with temperature [°F], air pressure [inch Hg] and height [ft] at 60 % relative humidity.

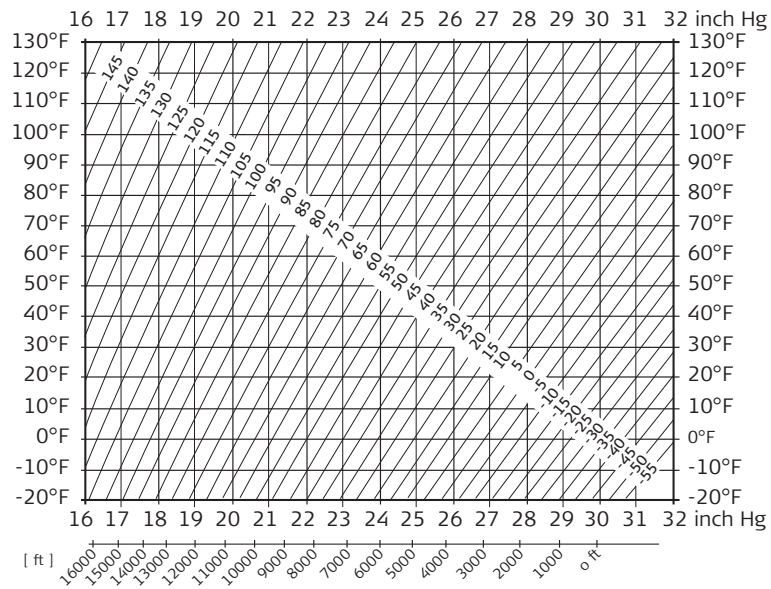

15.8

Reduction Formulas

Formulas

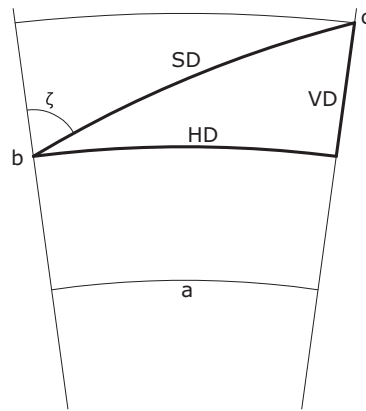

- a Mean Sea Level
- b Instrument
- c Reflector
- SD Slope distance
- HD Horizontal distance
- VD Height difference

The instrument calculates the slope distance, horizontal distance, and height difference in accordance with the following formulas. Earth curvature ($1/R$) and mean refraction coefficient ($k = 0.13$) are automatically taken into account when calculating the horizontal distance and height difference. The calculated horizontal distance relates to the station height and not to the reflector height.

Slope distance

$$SD = D_0 \cdot (1 + \text{ppm} \cdot 10^{-6}) + p$$

SD Displayed slope distance [m]

D0 Uncorrected distance [m]

ppm Atmospheric scale correction [mm/km]

p prism constant [m]

Horizontal distance

$$HD = Y - A \cdot X \cdot Y$$

HD Horizontal distance [m]

$$Y = SD \cdot |\sin\zeta|$$

$$X = SD \cdot \cos\zeta$$

$$A = (1 - k/2)/R = 1.47 \cdot 10^{-7} \text{ [m}^{-1}\text{]}$$

ζ = Vertical circle reading

k = 0.13 (mean refraction coefficient)

R = 6.378 * 10⁶m (radius of the earth)

Height difference

$$VD = X + B \cdot Y^2$$

VD Height difference [m]

$$Y = SD \cdot |\sin\zeta|$$

$$X = SD \cdot \cos\zeta$$

$$B = (1 - k)/2R = 6.83 \cdot 10^{-8} \text{ [m}^{-1}\text{]}$$

ζ = Vertical circle reading

k = 0.13 (mean refraction coefficient)

R = 6.378 * 10⁶m (radius of the earth)

Software Licence Agreement

This product contains software that is preinstalled on the product, or that is supplied to you on a data carrier medium, or that can be downloaded by you online according to prior authorisation from GeoMax. Such software is protected by copyright and other laws and its use is defined and regulated by the GeoMax Software Licence Agreement, which covers aspects such as, but not limited to, Scope of the Licence, Warranty, Intellectual Property Rights, Limitation of Liability, Exclusion of other Assurances, Governing Law and Place of Jurisdiction. Please make sure, that at any time you fully comply with the terms and conditions of the GeoMax Software Licence Agreement.

Such agreement is provided together with all products and can also be referred to and downloaded at the GeoMax home page at <http://www.geomax-positioning.com/swlicense> or collected from your GeoMax distributor.

You must not install or use the software unless you have read and accepted the terms and conditions of the GeoMax Software Licence Agreement. Installation or use of the software or any part thereof, is deemed to be an acceptance of all the terms and conditions of such Licence Agreement. If you do not agree to all or some of the terms of such Licence Agreement, you must not download, install or use the software and you must return the unused software together with its accompanying documentation and the purchase receipt to the distributor from whom you purchased the product within ten (10) days of purchase to obtain a full refund of the purchase price.

Instrument axis

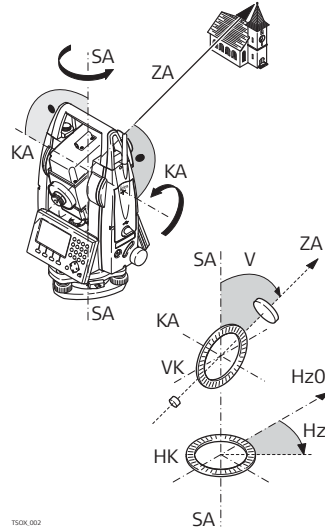

- ZA = **Line of sight / collimation axis**
Telescope axis = line from the cross hairs to the center of the objective.
- SA = **Standing axis**
Vertical rotation axis of the telescope.
- KA = **Tilting axis**
Horizontal rotation axis of the telescope. Also known as the Trunion axis.
- V = **Vertical angle / zenith angle**
- VK = **Vertical circle**
With coded circular division for reading the vertical angle.
- Hz = **Horizontal direction**
- HK = **Horizontal circle**
With coded circular division for reading the horizontal angle.

Plumb line / compensator



Direction of gravity. The compensator defines the plumb line within the instrument.

Standing axis inclination

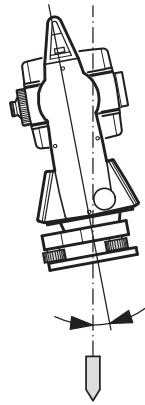

Angle between plumb line and standing axis. Standing axis tilt is not an instrument error and is not eliminated by measuring in both faces. Any possible influence it may have on the horizontal direction or vertical angle is eliminated by the dual axis compensator.

Zenith

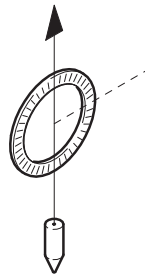

Point on the plumb line above the observer.

Crosshairs

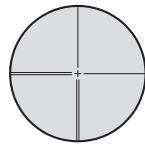

Glass plate within the telescope with reticle.

Line-of-sight error (horizontal collimation)

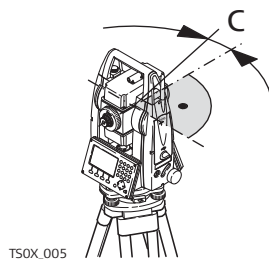

TS0X.005

The line-of-sight error (c) is the deviation from the perpendicular between the tilting axis and line of sight. This could be eliminated by measuring in both faces.

Vertical index error

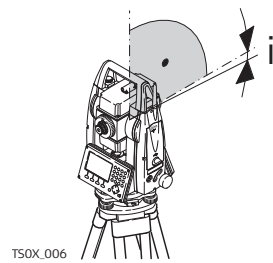

With a horizontal line of sight the vertical circle reading should be exactly 90° (100 gon). The deviation from this value is termed the Vertical index error (i).

Explanation of displayed data

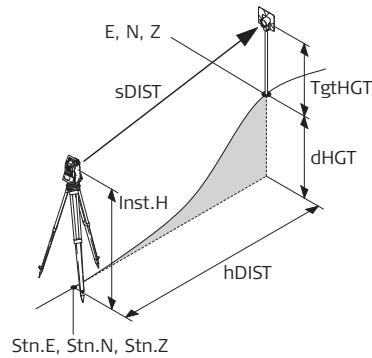

sDIST	Indicated meteorological corrected slope distance between instrument tilting axis and center of prism/laser dot
hDIST	Indicated meteorological corrected horizontal distance
dHGT	Height difference between station and target point
TgtHGT	Reflector height above ground
Inst.H	Instrument height above ground
Stn.E, Stn.N, Stn.Z	Easting, Northing and Height coordinates of station
E, N, Z	Easting, Northing and Height coordinates of target point



Depending on local firmware versions the menu items may differ.

Menu Tree



Apps

- |--- Survey
- |--- Setout
- |--- Station Setup
- |--- Missing Line Measurement
- |--- COGO
 - |--- Inverse, Traverse, Bearing-Bearing, Bearing-Distance, Distance-Distance, Line Intersection, Distance Offset, Set Point by Distance Offset, Plane Offset, Line Extension.
- |--- Area
- |--- Remote Elevation
- |--- Reference Line
- |--- Reference Arc
- |--- Construction
- |--- Road 2D
- |--- Road 3D
- |--- Traverse



Data

- |--- Jobs
- |--- Known Points
- |--- Observations
- |--- Code Library
- |--- Formats
- |--- Erase Job Memory
- |--- USB-Explorer



Settings



General

- |--- Tilt Correction, HA Correction, HA Increment, VA-Setting, V After Dist, Auto-Off, Angle Unit, Minimum Reading, Distance Unit, Distance Decimal, Temperature Unit, Pressure Unit, Grade Unit, Beep, Sector Beep, Setout Beep, Screen Illumination, Crosshair Illumination, Data Output, GSI Format, Mask, Code Saving, Language, Language Choise, Touch Screen, Double PtID, Sort Type, Sort Order, Pre-/Suffix, Identifier.

Units

- |--- Angle Unit, Minimum Reading, Distance Unit, Distance Decimal, Temperature Unit, Pressure Unit



EDM

- |--- EDM Mode, Prism Type, GeoMax Const., Abs. Const., Laser-Beam



Comm.

- |--- Port, Bluetooth, Baud Rate, Data Bits, Parity, Endmark, Stop bits, Acknowledge



R-Survey



Transfer





- |--- Export Data
- |--- Import Data



Tools



Calibration

		HA-Collimation
	--	Vertical Index
		Comp. Index
	--	
	--	
		Auto start
		System Info
		Instrument Information, Software Information, Set Date, Set-
	--	Time, Memory Information, Format
		Load Firmware
		Firmware, Languages Only
	--	
		PIN/PUK
		License keys
	--	

* Valid for Color&Touch displays only

Appendix B

Directory Structure

Description

On the USB memory stick, files are stored in certain directories. The following diagram is the default directory structure.

Directory Structure

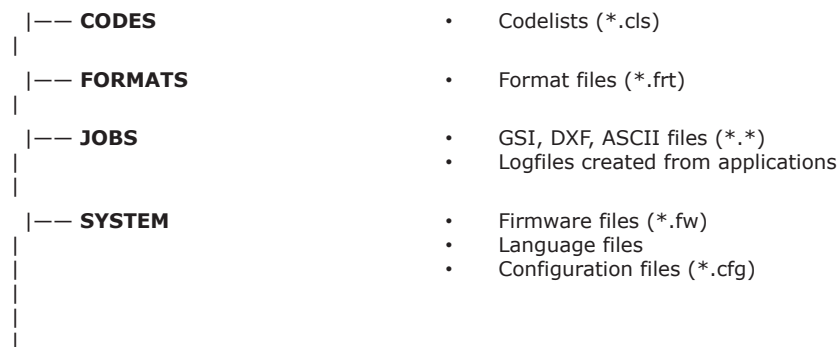

Appendix C

Connector PIN Layout

Connector PIN layout

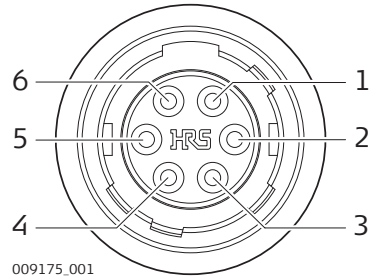

Pin number	Name	Function	Direction
1	GND	Signal Ground	
2	PWR_IN/ USB_V Bus	Power-In, 10..15V (typical 12V) / USB 5V	In
3	TH_Tx	RS232, Transmit	Out
4	TH_Rx	RS232, Receive	In
5	D_Minus	USB, Signal Low	
6	D_Plus	USB, Signal High	



866480-1.1.0en

Original text

© 2018 GeoMax AG, Widnau, Switzerland